

Improving the reliability of temperature measurements up to 1550 °C

— Establishing the temperature standards and calibration system for thermocouples —

Masaru Arai^{*}, Hideki Ogura and Masaya Izuchi

[Translation from *Synthesiology*, Vol.3, No.1, p.1-15 (2010)]

Since late 1990's, the reliability of temperature measurements at high temperatures was remarkably upgraded by establishing the national measurement standards for calibration of thermocouples up to 1550 °C, and by implementing the traceability system. The traceability system, structured as a hierarchical link of calibrations between the national measurement standards and practical measurements, was designed in consideration of various elements such as availability of the measurement standards and sharing the responsibility with accredited calibration laboratories. The optimized scheme for industries in Japan was established by promoting a balanced combination of conventional techniques held by accredited calibration laboratories and progressive technology, taking into account the spread of the progressive technology.

Keywords : Thermocouple, measurement standard, calibration, temperature fixed point, eutectic point

1 Introduction

This paper describes in the framework of “synthesiology” about the development of the national measurement standard for a temperature range of 1000 °C to 1550 °C, and the establishment of a system that disseminates these temperature standards to the users in the field via the calibration laboratories, as a response to the rising demand from industry for the improvement of reliability of temperature measurement. Measurement standards will never find its importance until it is widely used in society. To implement a system that enables every on-site measurement to be traceable to the national standard, a system design that combines both the technologies that are currently available and those newly developed should be desirable. In this paper, the construction of a high-temperature standard system is discussed in detail, by focusing on the technological background of a newly developed transfer standards. We present the process of designing and forming such a standard system, by selecting the optimum among various scenarios upon the background, choosing the essential elements for ensuring high reliability of temperature measurement, and actually integrating these elements to accomplish our objective.

2 Social demands for high temperature measurement

The temperature range from 1000 °C to 1550 °C is important for the material (iron, steel, etc.) industries, the heat-treating process in the parts manufacturing industries and the semiconductor process industries. Considering the fact that thermocouples^{Term 1} are the most commonly used

thermometers for this temperature range, it is necessary to build a temperature standard traceability system for thermocouple calibration.

In Japanese industry, the standardization of the calibration and the testing method on thermocouples has been started in a relatively early times, leading back to the 1960s, when numerous investigative researches and joint experiments were performed by academic societies and industrial associations to ensure the reliability of temperature measurements. One of the achievements was a method for calibrating the noble metal thermocouples using the melting point of palladium (1553.5 °C). The driving force of this development was the iron and steel industry that required measurements of the molten steel temperature at around 1500 °C with a precision of approximately 2 °C. Another achievement was a joint research for establishing a calibration method for the noble metal thermocouples based on the temperature fixed point^{Term 2} up to 1100 °C. This joint research was motivated by an increased demand in the semiconductor-process industry in the 1980s, for fulfilling the technical requirements for the Class 1 thermocouple^[1], the highest precision standard as designated by the International Electrotechnical Commission (IEC) for the temperature range up to around 1100 °C.

While, on one hand, such efforts were made in industry, it had been regrettable on the other hand that the national measurement standards that should be the reference were not sufficiently prepared at the time. There was, therefore, no way to verify either the calibration methods developed by industry or the reliability of thermometers calibrated

National Metrology Institute of Japan, AIST Tsukuba Central 3, 1-1-1 Umezono, Tsukuba 305-8563, Japan * E-mail : masaru-arai@aist.go.jp

Original manuscript received September 1, 2009, Revisions received January 25, 2010, Accepted February 5, 2010

by them. To solve this issue, the national measurement standards are developed and the temperature standard system is constructed. The aim is that the developed national measurement standards are transferred to the user's thermometers, and further, the calibration values declared by the calibration laboratories or thermometer manufacturers become verifiable, so that the reliability of thermometers widely used in society can be ensured.

3 Selection of scenario for the thermocouple traceability

In this chapter, the framework of the traceability system of thermocouples will first be described. It is followed by the description of the selection of scenarios that leads to the most-fit system design and the consideration on elements essential for implementing the selected scenario.

3.1 The framework of the thermocouple traceability system

Figure 1 shows the basic framework of the national measurement standards for temperatures in the range between 1000 °C and 1550 °C, and the traceability system for the thermocouples that uses these standards.

AIST maintains a series of temperature fixed points as national measurement standards. The freezing point of pure copper (1084.62 °C) and the freezing point of pure silver (961.78 °C) are temperature fixed points used conventionally by many metrology institutes around the world, including Japan. The temperature values at the freezing points are defined by an international agreement. The melting point of pure palladium (1553.5 °C) is also occasionally used as the high temperature fixed point in several countries.

The metal-carbon eutectic points are the newly proposed fixed points by AIST. There is a wide temperature range of about 500 °C between the copper point and palladium point, and from the perspective of disseminating temperature standards, finding applicable fixed points along that

temperature range has a great significance. To this concern, therefore, AIST initiated research at the earliest time on finding possibilities of metal-carbon eutectic points to be used as the national measurement standards.

For transferring the national measurement standards from AIST to the thermocouple calibration laboratories, a transfer standard, which carries the temperature standard, is necessary. The transfer standard must possess high reliability to reproduce the standard accurately, and must be sufficiently robust to maintain the standard accurate during transportation. In practice, it must also be light-weight and low-cost. To these conditions, we considered two types of thermocouples as candidates. The first was the thermocouple that uses platinum-rhodium alloy with 13 % rhodium content and pure platinum as wires (type R thermocouple), and the other was the one that uses pure platinum and pure palladium as wires (platinum/palladium or Pt/Pd thermocouple). Both types are applicable for high temperature measurement. Although the type R thermocouple has already been used widely, there are some problems in stability at high temperatures. The Pt/Pd thermocouple was newly developed, and while a better stability was expected than the type R thermocouple, the related case studies were not significantly available, and the properties such as stability were not sufficiently understood.

After receiving the transfer standard already calibrated at AIST, the calibration laboratories transfer the temperature standards to the working standard they are maintaining. In Japan, most of the calibration laboratories use temperature fixed-point device as their own working standard. In this case, the calibration laboratories can calibrate the field users' thermocouples using their own temperature fixed-point device.

3.2 Scenario selection

AIST considered the scenarios from two perspectives: (a) what artifact is to be selected as the transfer standard, (b) what temperature fixed points are to be used for disseminating the calibration service. The national metrology institutes worldwide are always in competition in research and development for setting the measurement standards, where some new methods are proposed or conventional methods are improved upon further evaluation. For a national metrology institute, it is ideal to start by integrating those achievements, setting measurement standards of top level quality, and creating a traceability system based on them. On the other hand, for a calibration laboratory, it is more convenient to employ conventional methods already adopted, because the equipments already owned can be operated as they used to be, along with the accustomed calibration procedures. Four scenarios below were considered from these two opposing standing points, as shown in Fig. 2.

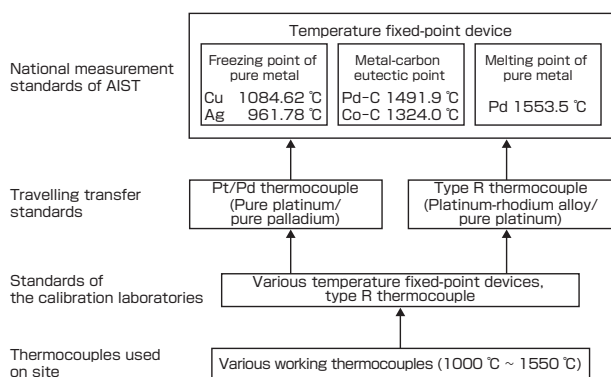

Fig. 1 Basic framework of the high-temperature traceability for thermocouples.

- In the case where only type R thermocouple is the transfer standard

Scenario (1): AIST calibrates one type R thermocouple at the three temperature fixed points (Ag, Cu, and Pd fixed points), and expresses the relationship of temperature and thermal electromotive force (emf) between 960 °C and 1550 °C as a function based on the emf values (calibration values) at each point. This function is provided to the calibration laboratory as the standard.

Scenario (2): AIST either calibrates one type R thermocouple at the three temperature fixed points (Ag, Cu, and Pd fixed points) or, otherwise, calibrates three separate type R thermocouples, one at each of the three temperature fixed points (Ag, Cu, and Pd fixed points), and provides the emf values (calibration values) as the standards to the calibration laboratory.

- In the case where both Pt/Pd thermocouple and type R thermocouple are the transfer standards

Scenario (3): AIST calibrates two Pt/Pd thermocouples, one at each of the two fixed points (Ag and Cu fixed points), calibrates the type R thermocouple at one temperature fixed point (Pd fixed point), and provides the emf values (calibration values) as the standards to the calibration laboratory.

- In the case where Pt/Pd thermocouples are the transfer standards

Scenario (4): AIST calibrates four separate Pt/Pd thermocouples, one at each of the four temperature fixed points (Ag fixed point, Cu fixed point, Co-C eutectic point^{Term 3}, and Pd-C eutectic point), and provides the emf values (calibration values) as the standards to the calibration laboratory.

The important considerations for the above four scenarios are (a) what is to be selected as the transfer standard, and (b) what temperature fixed points are to be selected as the calibration temperature. The technical difficulties increase in the order from the Scenario (1) to the Scenario (4).

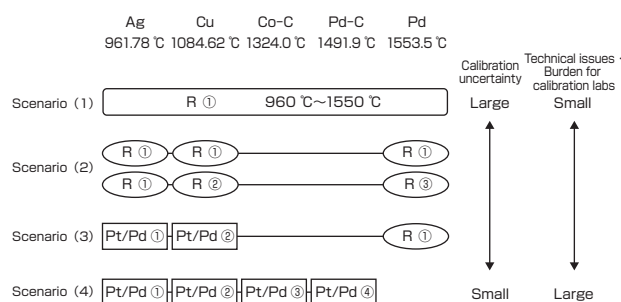

Fig. 2 Comparison of the scenarios for thermocouple traceability.

“R” and “Pt/Pd” represent the type R thermocouple and the Pt/Pd thermocouple that are used as transfer standards, and the circled numbers are for individual identification.

In the Scenario (1), it is more efficient to provide the calibration service from AIST directly to the thermometer users without intermediation by any calibration laboratory. This scenario is occasionally selected by the metrology institutes in the developing nations. The calibration uncertainty is the largest among the four scenarios.

Scenario (2) is convenient for the calibration laboratories that would be receiving the transfer standard because they can use the devices they already operate. However, for example, if the uncertainty of calibration service of the type R thermocouple at 1000 °C is set to be 0.3 °C, the uncertainty of the working standard of the calibration laboratory should be within 0.1 °C, which is approximately one-third the value. This figure is not easy to achieve in this scenario. As will be explained in chapter 4, there is a limit in the stability of the type R thermocouple when being used as the transfer standard.

Scenario (4) places the metal-carbon eutectic point, which is a recent research product, as the national measurement standard. It is an excellent method that can incorporate the findings of upcoming future research. However, the dissemination of the standard under this scenario involves the vast investment to introduce new facilities and the learning of new skills by the calibration laboratories, and their workload will increase. Although AIST positions Scenario (4) as an optimum solution for the future, Scenarios (2) and (3) that use the temperature fixed points are the practical solutions that could be readily adopted by the thermometer manufacturers and the calibration laboratories. Thus we have initially selected Scenarios (2) and (3) for the time being, and the preparations toward Scenario (4) has also been started.

AIST has been disclosing and updating the Measurement Standards Development Program for various quantities including temperature since 2001. Since this program clearly states when and which national measurement standards will be prepared, it is possible for the industry to prepare the necessary facilities and personnel for providing the calibration service, and to start the calibration service according to the release for the dissemination of the national measurement standards. AIST announced the commencement of the calibration service for thermocouples using the Ag and Cu fixed points as 2002 in this the Measurement Standards Development Program, and conducted research on the transfer standards using the available interval. The study sessions of the temperature-related academic societies and industrial associations were held almost every month. There, the status of standard development at AIST was reported, the thermometer calibration by the thermometer manufacturers and calibration laboratories were discussed, and the technical data obtained by AIST for the calibration of the transfer standard using the Ag and Cu fixed points were presented.

After numerous sessions of such information and opinion exchanges, the following agreement was reached between AIST and industry. While using the type R thermocouple as the transfer standard might be an easy solution, the uncertainty due to the inhomogeneity of the thermocouple will increase (explained in section 4.2.1). The demand from the thermometer manufacturers was to achieve a sufficiently small uncertainty that matches the quality of Class 1 thermocouple as designated by the IEC standards. It was recognized that the development of the transfer standards with small uncertainty and their dissemination in synch with the establishment of the national measurement standards would be a great advantage. The details of this R&D will be explained in section 4.2. Since there was a technical prospect for achieving small uncertainty of approximately 0.1 °C, we decided to select Scenario (3) that employed the Pt/Pd thermocouples as the transfer standards for the Ag and Cu fixed points.

3.3 Elements for the implementation of the scenario

The policy taken was to first quickly employ Scenario (3) to provide the advanced standard to industry, and then move toward Scenario (4) for further advancement. Elements ① to ⑥ were selected as the elements necessary for AIST to implement these scenarios.

- ① Fabrication of temperature fixed-point devices that would serve as the national measurement standards for high temperatures and the evaluation of their uncertainty
- ② Development of the stabilization technique of Pt/Pd thermocouples as transfer standards
- ③ Technique to calibrate transfer standards at temperature fixed points and the evaluation of their uncertainty
- ④ Confirmation of equivalence of the national measurement standards by international comparison
- ⑤ Building and operation of a quality management system to ensure regular and accurate provision of the calibration service
- ⑥ Designing a practical traceability system and drafting of the technical documents

The traceability system for high temperatures was attempted to be built by integrating and synthesizing the above elements.

Element ① involved the setting of the temperature fixed points as the national measurement standards. To realize Scenario (3), the freezing point of silver (961.78 °C), the freezing point of copper (1084.62 °C), and the melting point of palladium (1553.5 °C) were developed as the national measurement standards. Also, to progress to Scenario (4) in the future, Co-C eutectic point (1324.0 °C) and Pd-C eutectic point (1491.9 °C) were selected as new national measurement standards, and their researches were started. To provide the emf of thermocouples at each temperature fixed

point as standards to the calibration laboratories, the type R thermocouple was selected as the transfer standard for the palladium melting point. For temperatures below 1500 °C, Pt/Pd thermocouple was selected as the transfer standard. Element ② was the development of this Pt/Pd thermocouple.

Element ③ was the technique to calibrate the transfer standard using the prepared fixed-point device, and the evaluation of the calibration uncertainty. Element ④ involved the comparison of the standards with the other competitive national standard institutes. This was carried out to confirm the international equivalence of the national measurement standards and the calibration technique. The method for conducting the international comparison was determined internationally, and 12 metrology institutes under the international organization called the Asia Pacific Metrology Programme (APMP) that was established for the Asia Pacific region participated.

Element ⑤ concerned the development of the system to ensure that AIST could conduct regular and accurate provision of the calibration service using the established national measurement standards. Element ⑥ was the traceability system of the temperature standards where the calibration laboratories would use the prepared measurement standards to calibrate the thermometers that would be used by industry. The drafting of the technical document that served as the basis for the third party to check the technical level of the calibration laboratory was also an important element. This document confirmed the calibration capability of the calibration laboratories.

The details of Elements ① to ⑤ will be explained in sections 4.1 to 4.5. Element ⑥ is discussed in chapter 5.

4 Preparation of the national measurement standards and development of the transfer standards

4.1 Element 1: Fabrication and evaluation of the fixed-point device

To realize the temperature fixed points for thermocouple calibration, it is known that there are two methods. One is the method using a crucible (crucible method) where the temperature fixed point is realized by melting or freezing of the metal founded in a crucible, and the other is the wire-bridge method where the temperature fixed point is realized by melting of metal directly attached at the measuring junction of the thermocouple for calibration. Since the crucible method indicates excellent reproducibility of the fixed-point temperature, and maintains the melting or freezing state over a long period, this method is generally used to realize the many temperature fixed points accurately. On the other hand, the wire-bridge method does not require a crucible to realize the temperature fixed point, and accordingly, it is

simple and the calibration can be conducted with only a small amount of the fixed-point material of 0.1 g or less. The wire-bridge method is generally used in cases where the crucible material may contaminate the fixed-point material, or metals indicating high melting point, such as noble metals, is used as the fixed-point material. In order to start the calibration service of the thermocouples, AIST employed the crucible method for realizing the Ag fixed point, the Cu fixed point, and the Co-C eutectic point because of good reproducibility of the freezing and melting points. The wire-bridge method was used for realizing the Pd fixed point.

4.1.1 Ag fixed-point device

Figure 3 shows the schematic cross section of the Ag fixed-point device. The fixed-point device was mainly composed of the “fixed-point furnace” consisting of a heater and a control system, and the “fixed-point cell” that held the silver ingot as fixed-point material. A vertical electric furnace containing a sealed sodium heat pipe was used as the fixed-point furnace which indicated the high temperature stability within ± 25 mK for 9 hours around 960 °C, and excellent temperature uniformity within ± 6 mK over 14 cm height. The silver ingot with nominal purity 99.9999 % was 1390 g in weight and founded in a graphite crucible which was sealed in the fixed-point cell. This cell was an open type that allowed monitoring of gas pressure on the ingot. The freezing point temperature could be maintained for 5 hours within ± 10 mK, and the standard deviation of reproducibility in 14 measurements was 3.8 mK^[2]. By using this device, it was evaluated that thermocouples could be calibrated with the expanded uncertainty of 0.09 °C at the Ag fixed point (level of confidence of approximately 95 %).

4.1.2 Cu fixed-point device

Figure 4 shows the schematic cross section of the Cu fixed-point device. As in the aforementioned Ag fixed-point device, this device consisted of the “fixed-point furnace” composed of the heating element, control system and the “fixed-point cell”

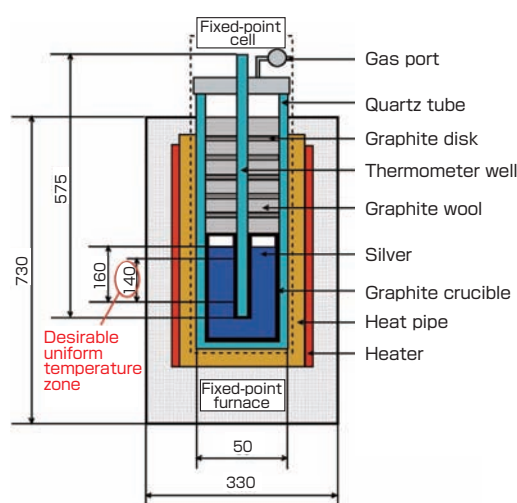

Fig. 3 Schematic diagram of the Ag fixed-point device.

that held the fixed-point material. The fixed-point furnace was a vertical electric furnace with three-zone heater in a vertical direction for temperature control. Kanthal wires were wound noninductively as heaters, and type R thermocouples were installed in the center of each zone as the controlling thermocouple. The design characteristics of this fixed-point furnace compared with the conventional 3-zone electric furnace were the improvement of the heat contact between controlling thermocouples and heaters, and the improvement of heat-retention of the furnace by thickening insulation material. The quick response of the controlling thermocouple was realized by attaching them to the alumina tube on the heater, to improve the temperature control of the furnace. The high-temperature refractory fiber (ceramic fiber) was used as insulation around the heating elements, the thickness of which was over 150 mm to increase the heat-retention of the furnace. Due to these improvements, the electric power consumption was reduced below 1 kW. The fixed-point cell was the open type as shown in the Ag fixed-point, and 1450 g copper with nominal purity 99.9999 % was founded in a graphite crucible. Figure 5 shows the temperature inside the fixed-point cell during the freezing of the copper. The temperature at the freezing point was maintained for 8 hours within ± 2 mK. The standard deviation of reproducibility of the freezing point measured by repeating the melting and freezing 26 times was 11.7 mK^[3], and it was evaluated that by using this device, thermocouples could be calibrated with expanded uncertainty of 0.11 °C at the Cu fixed point (level of confidence of approximately 95 %).

4.1.3 Co-C eutectic-point device

When a pure metal was founded in the graphite crucible for realizing its melting and freezing points above 1100 °C, the carbon that is the component of the crucible dissolved into

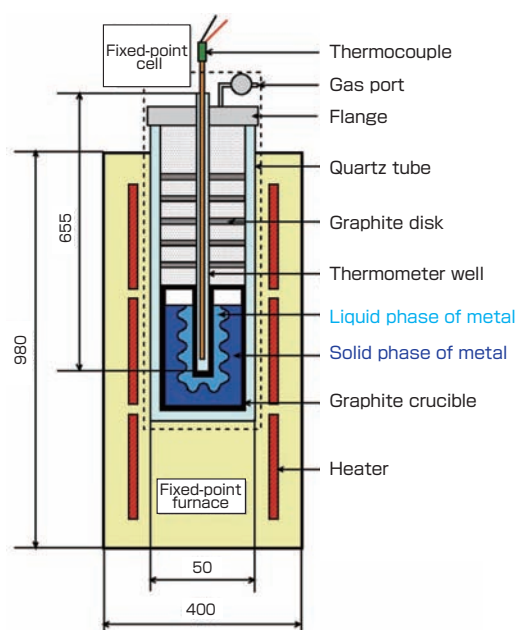

Fig. 4 Schematic diagram of the Cu fixed-point device.

the pure metal under high temperature, contaminated the pure metal, and decreased the melting and freezing points. This is the major reason that the temperature fixed point above 1100 °C could not be realized by using the pure metal with the graphite crucible. To solve this issue, it was proposed to mix the metal and carbon according to the ratio of the composition of eutectic alloy and then founding this mixture in the graphite crucible^[4]. This enabled the realization of a melting temperature with good reproducibility in the crucible and could be used as the temperature fixed point. The metal-carbon eutectic points are currently studied in the advanced national metrology institutes around the world as new fixed points for the high temperature range. Using this technique, the Co-C eutectic point device for the thermocouple calibration was developed. We succeeded in fabricating a large-sized Co-C eutectic point cell for the first time in the world, and demonstrated that it can be used for accurate thermocouple calibrations^[5]. In designing the device, the technique for the Cu fixed-point device was applied. Although a quartz tube was used to seal the crucible in the Cu fixed-point device, an alumina tube was used instead of quartz in the new device since devitrification or softening of quartz occur at the Co-C eutectic point temperature.

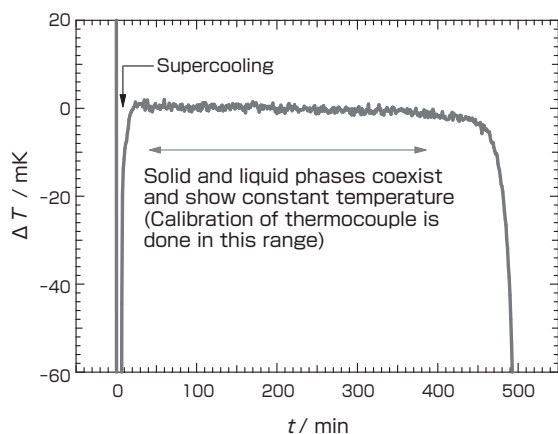

Fig. 5 Freezing curve at the Cu fixed point.

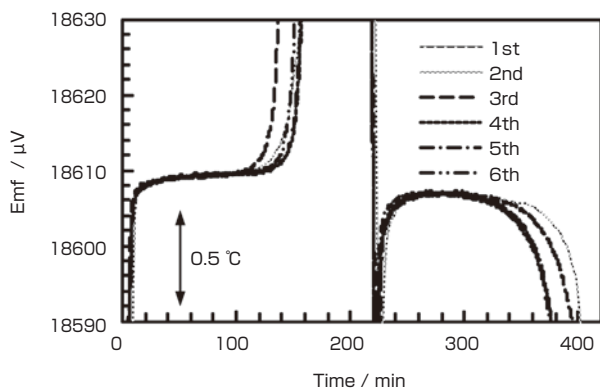

Fig. 6 Melting and freezing curves at the Co-C eutectic point.

Figure 6 shows the melting and freezing curves of the Co-C eutectic point. As a result of the uncertainty evaluation, it was found that thermocouples could be calibrated with the expanded uncertainty of 0.53 °C (level of confidence of approximately 95 %) at the Co-C eutectic point^{[6][7]}.

4.1.4 Pd fixed-point device

The wire-bridge method for realizing the melting point of palladium was mentioned earlier, and there were several techniques for attaching the fixed-point material to the thermocouple. As a result of experimental evaluation, it was found that attaching the coil-shaped palladium wire, as shown in Fig. 7, was effective in realizing a stable melting temperature^[8]. Figure 8 shows the emf of a type R thermocouple with coil-shaped palladium wire when the furnace temperature was increased gradually after inserting the thermocouple in the Pd fixed-point device. In 150 seconds, the sustained melting temperature in the range of ±0.05 °C was observed while the attached palladium wire was melting, and the average emf value in this range was obtained as the calibration emf value of the thermocouple at the Pd fixed point. As a result of the investigations, it was confirmed that the melting temperature could be realized with reproducibility

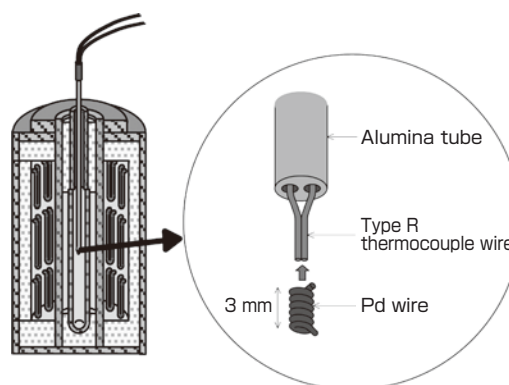

Fig. 7 Wire-bridge method to realize the melting point of palladium.

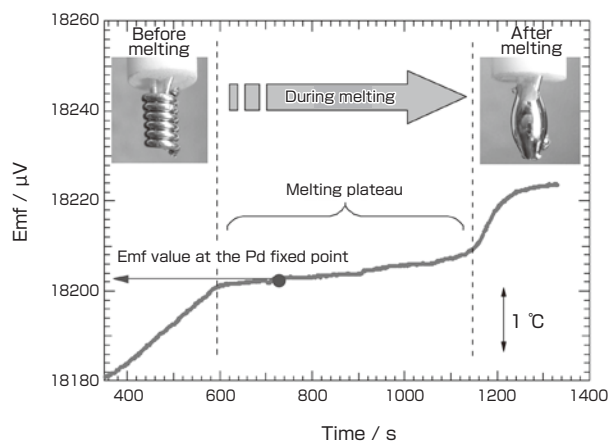

Fig. 8 Melting curve at the Pd fixed point.

of approximately 0.05 °C (standard deviation). By using this device, thermocouples could be calibrated with the expanded uncertainty of 0.79 °C (level of confidence of approximately 95 %) at the melting point of palladium.

4.2 Element 2: Technique for fabrication of stable Pt/Pd thermocouples

4.2.1 Drift and inhomogeneity of thermocouples

When transferring the temperature standard from the temperature fixed point to a thermocouple, the stability of the thermocouple itself is the largest component of uncertainty. Figure 9 shows the property changes of a new thermocouple when the thermocouple is inserted into a high-temperature furnace and the measuring junction is exposed to high temperature for a long time at a fixed insertion length. S is called the Seebeck coefficient of the thermocouple, and for simplification to consider, here, it is assumed that S has no temperature dependency. The E in the figure shows the electric field generated at the wire in the temperature gradient region, and the integration of E along the thermocouple wire is the emf that is actually observed using a voltmeter. E and S has the relationship $E = S dT/dx$ ^{[9][10]}. Here, x is the positional coordinate along the wire of the thermocouple.

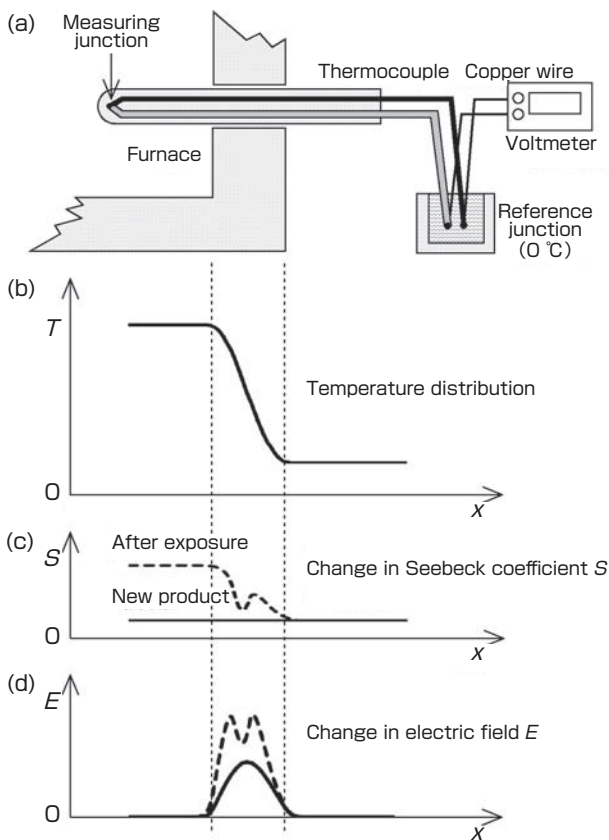

Fig. 9 Emf change by the exposure of thermocouple to high temperature.

The solid line indicates the Seebeck coefficient and the electric field of the new thermocouple, and the dashed line shows the values after exposure to high temperature.

When the new thermocouple is inserted into the furnace, in the beginning, the Seebeck coefficient S shows a constant value regardless of position x (this is called homogeneity), as shown by the solid line in Fig. 9(c). When the measuring junction is exposed to high temperature with the fixed insertion length of the thermocouple, the Seebeck coefficient of the part exposed to high temperature gradually changes due to the compositional and structural changes of the thermocouple wire and may become inhomogeneous in some parts, as shown by the dashed line in Fig. 9(c). With such changes in the Seebeck coefficient S , the electric field E changes as shown in Fig. 9(d), and the emf change is observed as a result. When the measuring junction is exposed to high temperature with the thermocouple fixed to a certain position, the emf change called the drift is observed. The tendency and magnitude of this emf change vary greatly depending on the type of thermocouples.

In the case where the temperatures of the measuring junction and the reference junction are constant, wherever the temperature gradient is on the position of the wire, the emf shows the same value regardless of the insertion depth, because the emf is determined by the temperatures of the measuring junction and the reference junction of the thermocouple that has homogeneous Seebeck coefficient S , as seen in the new thermocouple in Fig. 9(c). On the other hand, in the thermocouple that is exposed to high temperature for a long time in the furnace and a drift has been observed, the emf changes when the insertion length of the thermocouple

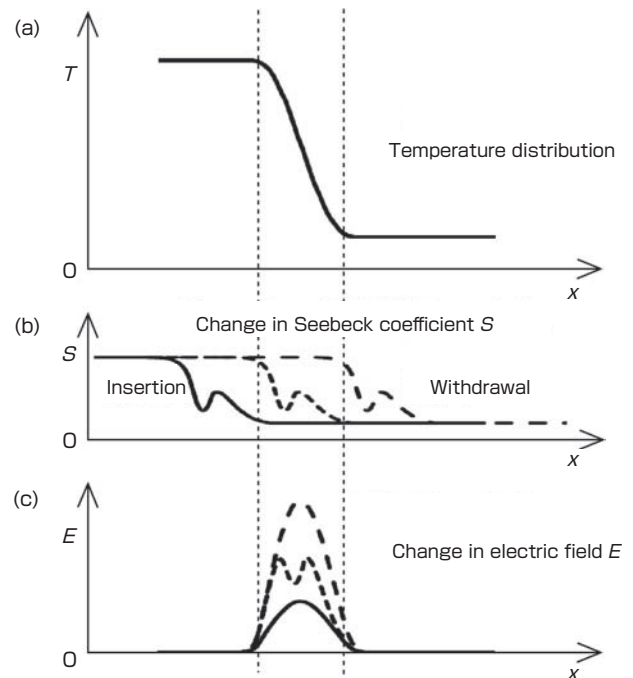

Fig. 10 Emf change when the insertion length of the thermocouple into high temperature furnace is altered.

The solid line shows the Seebeck coefficient and the electric field when the thermocouple exposed to high temperature is inserted, and the dashed line shows the values when it is withdrawn.

is changed as shown in Fig. 10. The thermocouple where the Seebeck coefficient differs according to the position of the wire is generally called the “inhomogeneous thermocouple.” In actual temperature measurement, the emf change generated when the position where the temperature gradient falls is changed by altering the insertion length of the thermocouple is often called “inhomogeneous.” In the inhomogeneous thermocouple, the emf is not determined by the temperature values of the measuring and reference junctions only, as it is dependent on the temperature distribution of the furnace. Therefore, the inhomogeneity may give erroneous standard if the calibrated transfer standard is used in different temperature gradient. The Seebeck coefficient S of the general thermocouple is temperature dependent, and a similar way of thinking is available.

4.2.2 Development of evaluation method of drift and inhomogeneity

As mentioned earlier, the drift and inhomogeneity of the thermocouple are extremely important factors when evaluating the stability of the transfer standard. Particularly, since the drift and inhomogeneity increase in the high temperature range, they become major components of the uncertainty of thermocouple calibration.

To evaluate the stability of the thermocouple, at first, we studied the drift and inhomogeneity of the Pt/Pd thermocouple fabricated according to the paper^[11] of the joint research of the National Institute of Standards and Technology (NIST) (USA), and the Istituto di Metrologia “Gustavo Colonnetti” (IMGC) (Italy). Following this paper, the wire annealing was performed for 10 hours at 1200 °C by direct current application to the thermocouple wires. After assembling the thermocouple, the annealing in a furnace was performed for 3 hours at 1100 °C, and then 10 hours at 450 °C.

The Cu fixed-point device was used to maintain the measuring junction of the thermocouple at a constant temperature, and the drift and inhomogeneity of the thermocouple

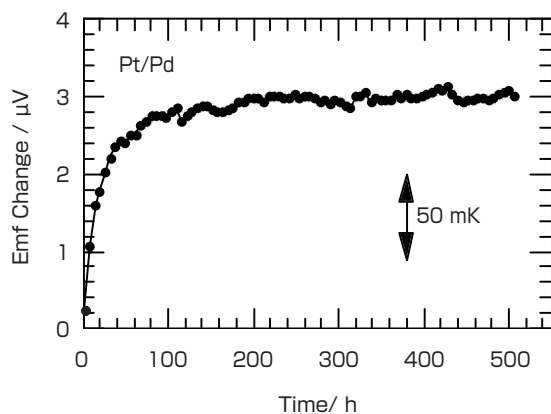

Fig. 11 Drift of the Pt/Pd thermocouple when exposed to the Cu fixed point.

was measured simultaneously using the stability and the uniformity of the freezing temperature of the fixed-point device^[12]. The measuring junction of the thermocouple was inserted to the position 1 cm above the deepest point of the measurement well of the Cu fixed-point device, the copper was repeatedly frozen and melted, and the emf changes were measured. The temperature control of the Cu fixed-point device was programmed to repeat the melting and freezing constantly, and the measuring junction of the thermocouple was always exposed to the Cu fixed-point temperature. Figure 11 shows the result of the measurement of *in-situ* drift for approximately 500 hours by fixing the position of the measuring junction. The emf of the Pt/Pd thermocouple changed markedly in the first 50 hours after starting the exposure, and showed almost constant value after 100 hours.

Figure 12 is a plot of the emf change when the thermocouple was moved up and down when the freezing of copper was in progress during the drift measurement. The position of the measuring junction when conducting the drift measurement was set as “0 cm”. The 0 hour to 505 hours in the figure is the time lapse from the start of exposure. The data at the start of exposure (0 h) was the measurement of the emf change when the thermocouple was pushed in at the rate of 0.5 cm/min, and the other data were the measurements taken when the thermocouple was pulled up at the rate of 0.5 cm/min. The act of “changing the insertion length of the thermocouple” to obtain the data for Fig. 12 was the same as

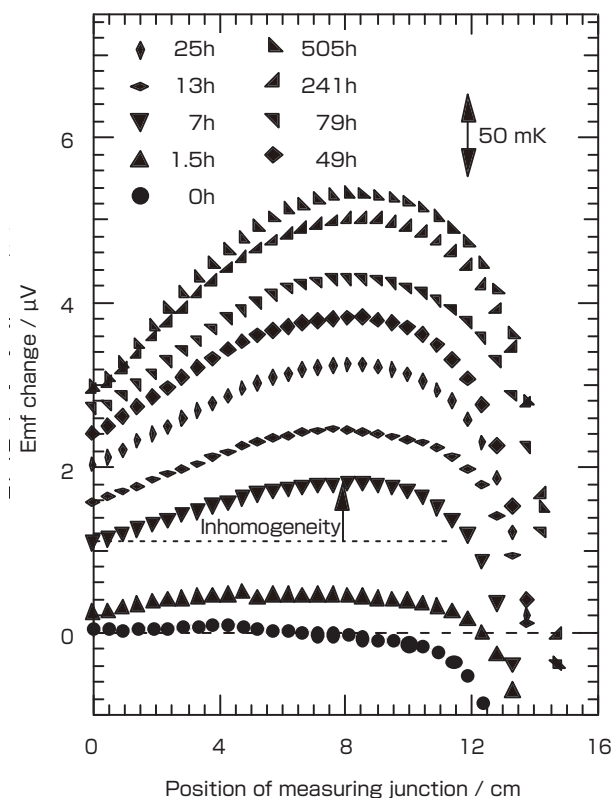

Fig. 12 Inhomogeneity of the Pt/Pd thermocouple when exposed to the Cu fixed point.

the act of “changing the temperature distribution along the wire of the thermocouple” while maintaining the temperature of the measuring junction, and the emf change reflected the inhomogeneity of the thermocouple. To quantitatively assess the inhomogeneity of the thermocouple, the emf change from 0 cm to upper 8 cm was defined as the “inhomogeneity” of the thermocouple, as shown in the example for 7 hours in Fig. 12.

The stability of the thermocouples at a temperature fixed point could be evaluated almost automatically in large amounts using this method, and the stable development and evaluation of the transfer standard that will be explained in the next section could be done efficiently.

4.2.3 Fabrication of the stable thermocouple

The Pt/Pd thermocouple is composed of the platinum and palladium wires that are pure metals, and it is reported that the emf change due to inhomogeneity is mostly related to the palladium wire^[13]. To investigate the effect of the palladium wire from different lots, four Pt/Pd thermocouples were fabricated using the palladium wires from four different lots with the same nominal purity of 99.99 %^[14]. Here, the four fabricated thermocouples will be called TC-a, TC-b, TC-c, and TC-d. Of the palladium wires from four different lots, the wires of TC-a and TC-b were made by the same manufacturing procedure by the same manufacturer. The wires of TC-c and TC-d were each purchased from manufacturers different from that of TC-a and TC-b. The electric current was applied to heat the wires for 10 hours at 1200 °C. After assembly, the thermocouple was annealed in a furnace for 3 hours at 1100 °C, and finally 10 hours at 450 °C.

Figures 13 and 14 show the results of the measurements of the drift and the inhomogeneity of these thermocouples,

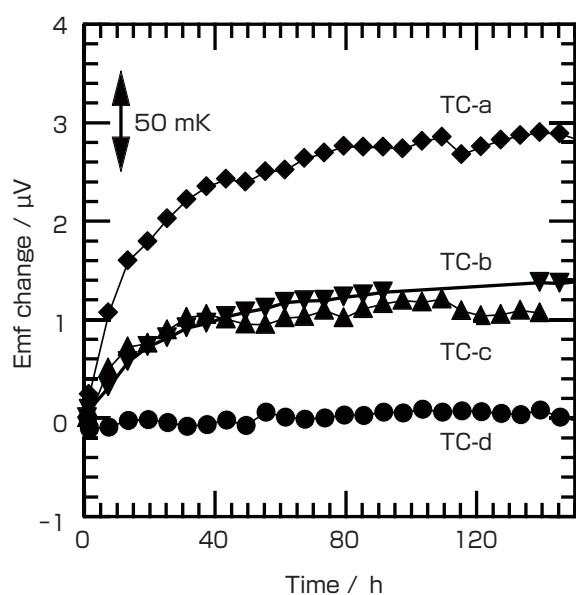

Fig. 13 Drift of the Pt/Pd thermocouples using palladium wires from different lots.

respectively. It can be seen that the changes of the drift and inhomogeneity differ by different lots even if the palladium wires were made by the same manufacturing procedure by the same manufacturer, as seen in TC-a and TC-b. On the other hand, TC-d showed small drift and inhomogeneity. This indicates that the drift and inhomogeneity can be greatly reduced by selecting an appropriate palladium wire lot. However, it is not easy to obtain a steady supply of the wire used in TC-d. Therefore, we investigated a method for reducing the drift and inhomogeneity using the wires that are relatively readily available, as used in TC-a, TC-b, and TC-c.

Since the heat treatment in the furnace was the final procedure in the heating history of thermocouples before they were actually used, we thought this was most deeply involved in the property of the thermocouples. Therefore, after 3 hours heat treatment at 1100 °C in the furnace to remove the wire strain, we fabricated a total of 11 thermocouples with different final heat treatments by conducting the final heat treatment at temperature points in the range from 450 °C to 1080 °C. For the palladium wire of the thermocouple, the wires from the same lot as TC-a that showed the largest drift were used. Also, since the emf of the Pt/Pd thermocouple in Fig. 11 stabilized at 100 hours, we selected 100 hours as the length of the final heat treatment.

Figure 15 shows the drift of the emf when the 11 Pt/Pd thermocouples fabricated as above were exposed to 1085 °C using the Cu fixed-point device, and Fig. 16 shows the inhomogeneity of the same thermocouples. The temperatures in the figure are final heat treatment temperatures. For reference, the result for the thermocouple annealed for 10 hours at 450 °C was plotted as black dots. In all thermocouples, the emf stabilized at approximately

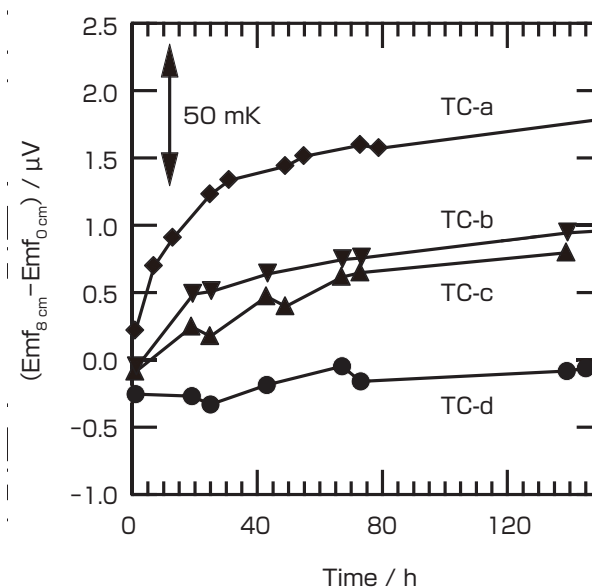

Fig. 14 Inhomogeneity of the Pt/Pd thermocouples using palladium wires from different lots.

100 hours after exposure to 1085 °C. Largest change was seen in emf at 100 hours at approximately 4 μV (corresponds to approximately 0.2 K) when the final heat treatment temperature was 730 °C. Here, it should be noted that the thermocouples that underwent 100 hours final heat treatment at 850 °C or 1030 °C showed very small drift and inhomogeneity. The emf change was within 0.5 μV (corresponds to 24 mK) over 150 hours, and this showed that the drift and inhomogeneity of the Pt/Pd thermocouple can be kept low by conducting appropriate heat treatment^[12].

As a result of conducting similar measurement of the drift and inhomogeneity for the exposure to 962 °C using the Ag fixed-point device, it was found that the effect of the final heat treatment at 850 °C was effective for different lots of wire^[15]. Also, as a result of similar measurement for the exposure to 1324 °C using the Co-C eutectic point, it was found that the final heat treatment at 1030 °C was effective in reducing the drift at the Co-C eutectic point^[16]. In the exposure to temperature lower than the Ag fixed point, the drift and inhomogeneity of the Pt/Pd thermocouple decreased rapidly^[17]. The above results mean that the drift and inhomogeneity of the Pt/Pd thermocouple at temperatures up to 1330 °C can be kept extremely small by selecting the appropriate wires, the fabrication method, and the heat treatment method^[16]. We were able to find a method for reducing and stabilizing the drift and inhomogeneity at each temperature of the Ag fixed point, Cu fixed point, and Co-C eutectic point.

4.2.4 Comparison between Pt/Pd thermocouple and type R thermocouple

In case of the type R thermocouple, the emf tended to

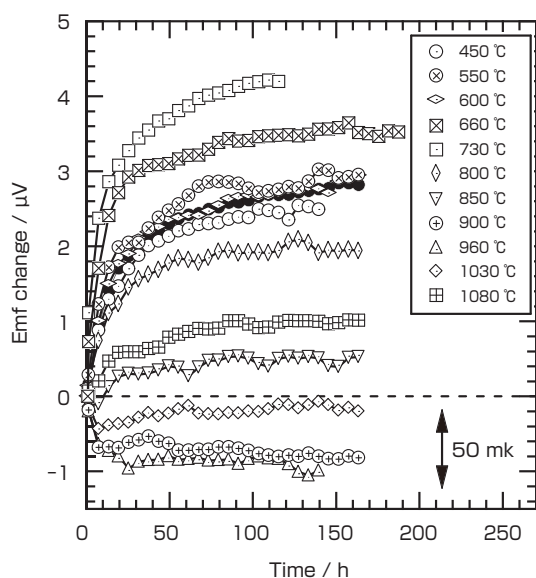

Fig. 15 Drift of the Pt/Pd thermocouples annealed at different temperatures as final heat treatment.

decrease gradually with exposure to 1085 °C, and drifted approximately 0.2 °C after 300 hours exposure^{[9][14]}. In contrast, as shown in Fig. 15, in the Pt/Pd thermocouple with appropriate final heat treatment, the drift was held within 0.03 °C even after 150 hours exposure to 1085 °C. As in the drift, the inhomogeneity of the type R thermocouple continued to change gradually while the Pt/Pd thermocouple with appropriate final heat treatment showed almost constant value within 0.04 °C at approximately 150 hours, as shown in Fig. 16. Due to these clear differences, we selected the Pt/Pd thermocouple as the transfer standard for Ag fixed point, Cu fixed point, and Co-C eutectic point. On the other hand, since the Pt/Pd thermocouple used palladium as its wire, it could not be used at the Pd fixed-point temperature because it would melt. Therefore, we decided to use the type R thermocouple, which had been used widely for a long period of time in Japan, as the transfer standard for the Pd fixed point.

4.3 Element 3: Evaluation of the uncertainty of fixed-point calibration

There are several sources of uncertainty when providing the temperature standard at the temperature fixed point as the national measurement standard using the thermocouple as the transfer standard. As an outline, the sources are: “the uncertainty inherent in the fixed-point device,” “the uncertainty inherent in the measurement system (voltmeter, reference junction device, etc.) when calibrating the thermocouple,” and “the uncertainty arising from the drift and inhomogeneity of the thermocouple itself that is being calibrated.” Table 1 shows the calibration uncertainty of the thermocouple at the Ag fixed point, Cu fixed point, Co-C eutectic point, and Pd fixed point. The expanded uncertainties (level of confidence of approximately 95 %) for the Ag fixed

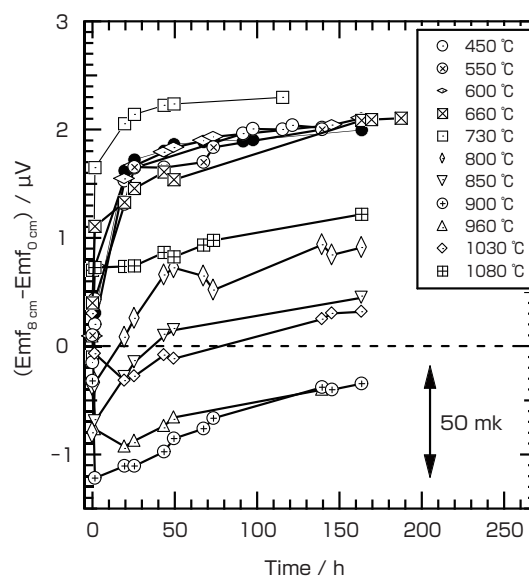

Fig. 16 Inhomogeneity of the Pt/Pd thermocouples annealed at different temperatures as final heat treatment.

point, Cu fixed point, Co-C eutectic point, and Pd fixed point are 0.09 °C, 0.11 °C, 0.53 °C, and 0.79 °C, respectively. This is the highest-level calibration capacity in the world, as described in the following section.

4.4 Element 4: Equivalence of the national measurement standard by international comparison

To investigate whether the realized fixed point was in accordance to the national measurement standards of other countries, an international comparison (APMP-T-S1-04) was conducted among the national metrology institutes of the Asia-Pacific region. Type R thermocouples were circulated among the participating institutes, each institute calibrated the type R thermocouple with their temperature fixed points, and the calibration values were compared with the value of the pilot laboratory. There were 12 national metrology institutes that participated: National Measurement Institute (NMI) (Australia); National Institute of Metrology (NIM) (China); Standards and Calibration Laboratory (SCL) (Hong Kong); National Physical Laboratory (NPL) (India); Research Center for Calibration, Instrumentation and Metrology, Indonesian Institute of Sciences (KIMLIPI) (Indonesia); Korea Research Institute of Standards and Science (KRISS) (Korea); Standards and Industrial Research Institute of Malaysia (SIRIM) (Malaysia); Standards, Productivity and Innovation Board (SPRING, currently NMC A*STAR) (Singapore); Council for Scientific and Industrial Research (CSIR, currently NMISA) (South Africa), National Metrology Institute of Japan (AIST/NMIJ); Center for Measurement Standards (CMS) (Taiwan); and National Institute of Metrology (Thailand) (NIMT) (Thailand).

Figure 17 shows the comparison result at 1084.62 °C, the freezing point of copper, and the differences of the calibration value between of the participating institutes and NMI, which was the pilot laboratory, are presented with the calibration uncertainties of each institute. The calibration uncertainty of AIST/NMIJ was the smallest-level among the participating institutes, and it was confirmed that the calibration value at the Cu fixed point matched almost completely at the level of uncertainty claimed by other countries.

Table 1 Calibration uncertainty of the thermocouples at each temperature fixed point.

Transfer standards	Pt/Pd thermocouples			Type R thermocouple
	Ag fixed point	Cu fixed point	Co-C eutectic point	Pd fixed point
Temperature of fixed point / °C	961.78	1084.62	1324.0	1553.5
Uncertainty of measurement system / °C	0.021	0.019	0.018	0.042
Uncertainty of fixed point realizing device / °C	0.014	0.021	0.260	0.231
Uncertainty of thermocouple itself / °C	0.034	0.045	0.060	0.315
Combined standard uncertainty of calibration / °C (Level of confidence of approx. 68 %)	0.042	0.054	0.267	0.393
Expanded uncertainty of calibration / °C (Level of confidence of approx. 95 %)	0.09	0.11	0.53	0.79

The combined standard uncertainty is the combination of individual uncertainty components, and is given by the positive square root of sum of squares of the uncertainties of the components.

The comparison of the calibration value at the Ag fixed point was conducted in the same international comparison, and as with the Cu fixed point, the calibration uncertainty of the Ag fixed point by AIST/NMIJ was the smallest-level, and the calibration values of each country matched almost completely at the uncertainty level claimed by them^[18].

For the Co-C eutectic point, AIST/NMIJ joined the Euromet Project 857^[19], a joint project of Physikalisch-Technische Bundesanstalt (PTB) (Germany), National Physical Laboratory (NPL) (UK), and Laboratoire Commun de Métrologie (LNE-Cnam) (France) that are the major European national metrology institutes. As the result of an international comparison in which Pt/Pd thermocouples and the Co-C eutectic cells were circulated, good agreement was obtained^[20].

4.5 Element 5: Constructing and operating the quality managing system for thermocouple calibration

Based on the quality management system for the calibration and testing service conducted by AIST, a technical manual of the calibration service for thermocouples was generated in 2004. To meet the requirements of the ISO/IEC 17025, the international standard for the calibration and testing laboratories, the particulars of personnel, facility and environmental condition, calibration method, equipment, traceability, handling of the calibrated device, reporting, and others were determined. According to this manual, the calibration would be conducted and the calibration records would be in safekeeping. The evaluation method for the drift and inhomogeneity that are uncertainty sources unique to the calibration of thermocouples were described in detail,

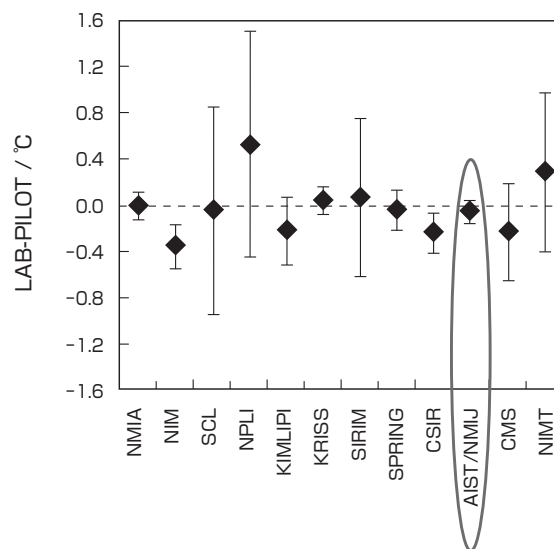

Fig. 17 The result of international comparison of the calibration value of type R thermocouple at the Cu fixed point (1084.62°C).

◆ indicates the difference between the calibration values of the participating institutes and NMI, and the error bar indicates the calibration uncertainty of each institute.

and the procedure for quantitatively evaluating the effects on the calibration value and uncertainties of the thermocouple was also described in the technical manual. In May 2006, the calibration service of the thermocouples by AIST was certified to be in accordance to the international standard under the certification program provided by the National Institute of Technology and Evaluation (NITE). The quality management system is the element that is necessary to regularly maintain the technique, where the calibration method for the thermocouples was established by careful evaluation of uncertainty and then verified by international comparison. It raises the reliability of thermocouple calibration conducted by AIST both domestically and internationally.

5 Element 6: Establishment of the traceability system

5.1 Design of the traceability system for thermocouples

The traceability system for temperature was constructed based on the JCSS^{Term4} system according to the “Measurement Act” in Japan. In this traceability system, the national measurement standards are used to calibrate transfer standards of the calibration laboratories which calibrate thermometers used in industry. As the national measurement standards, the fixed-point devices for the Ag fixed point (in 2002), the Cu fixed point (in 2002), and the Pd fixed point (in 2005) of AIST were designated as national primary standards by the Measurement Act. By following this Act, AIST provides the transfer standards with calibration values at these three points as the standards to the calibration

laboratories^{[21][8]}. The calibration laboratories calibrate their temperature scales by transferring the standard from the transfer standards to their fixed-point devices. However, for the Pd fixed point, the laboratories are allowed to select the method of transferring the standard by comparison calibration to working standard thermocouples instead of their fixed-point devices.

The transfer standards calibrated by AIST are the secondary standards as designated by the Measurement Act, and Pt/Pd thermocouples were employed for the Ag and the Cu fixed points and a type R thermocouple for the Pd fixed point. By providing the standard at the Pd fixed point using the thermocouple as the transfer standard, as shown in Fig. 18, calibration laboratories are now able to have the temperature standards up to 1554 °C for the working standard thermocouples, and to calibrate various thermocouples including the type R thermocouple using their working standard. Currently, AIST conducts approximately 10 calibrations a year for the secondary standards using the national primary standards, and issues the calibration certificates with the “jcss” mark designated by the Measurement Act to indicate that they were calibrated using the national primary standards.

Apart from the jcss calibration, AIST started the provision of the temperature standard at Co-C eutectic point upon request in 2009^[7]. This enabled a more accurate verification of the temperature scale created by the calibration laboratories.

The calibration laboratories registered to the JCSS can flexibly select various calibration services according to their own equipment, including the calibration of various fixed-point devices up to the Cu fixed point, fixed-point calibration up to the Cu fixed point for noble metal thermocouples (types R, S, B, and Pt/Pd), base metal thermocouples (types N, K, E, J, and T), and thermometers with indicators for high temperature range, as well as the comparison calibration of thermometers at temperature range to a maximum of 1554 °C^[22].

5.2 Joint research with Japanese calibration laboratories and drafting of the technical documents

To disseminate the Pt/Pd thermocouple as the standard thermocouple, the parties took a circulating test of the Pt/Pd thermocouple from June 2001 to March 2002 in the working group of the Temperature Measurement Subcommittee, under the 36th Committee on Industrial Instrumentation of the Japan Society for the Promotion of Science. With the objective of assessing the drift of thermocouples during calibration at the Cu fixed point, four Pt/Pd thermocouples were fabricated under the same condition from platinum and palladium wires taken from the single lot, and were subjected to tests. These thermocouples were transferred from “AIST → four labs → AIST,” and after conducting recovery annealing, they were sent to “AIST → remaining

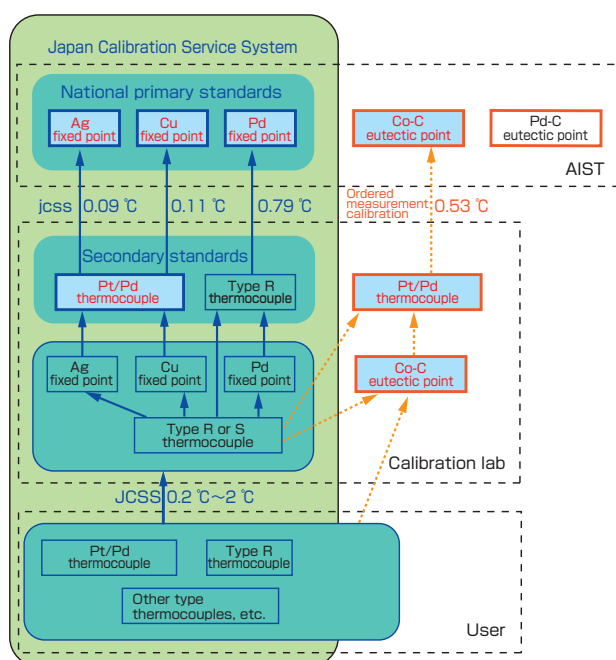

Fig. 18 Diagram of the traceability system of thermocouples for high temperature range (as of February 2010).

four labs → AIST” to investigate the degree of change of calibration values in the Cu fixed-point calibration by each calibration laboratories. Prior to the tests, investigations were performed based on the thermocouple fabrication facilities and calibration equipment of the calibration laboratories and AIST, of the specification of the materials such as the thermocouple wires and insulation tube to fabricate the Pt/Pd thermocouple, the assembling conditions such as the pretreatment of wires and insulation tubes as well as the heat treatment after assembly, and the condition of usage.

In the same working group, two joint experiments were conducted in 2004 by seven laboratories including AIST as the “Joint Experiment including the Calibration of Type R Thermocouples at Pd Fixed Point”^{[23]-[25]}.

For the calibration laboratory to register to JCSS, it must comply with the guideline for the technical requirement items. This guideline is to clarify the technical requirements established by the international standard ISO/IEC 17025 and to provide explanation to the calibration laboratories. This technical document was published and issued by NITE. This also serves as technical criteria by which the third party recognizes the technical competence for the calibration conducted by a calibration laboratory. The conditions for the secondary standards or the regular reference standards were determined based on the results of the above joint experiments. Cautions pertaining to the handling of inhomogeneity were also described^[26].

6 Impact of standard development and future issues

6.1 Effect of the development of the traceability system for thermocouples

As the actual effect of constructing the traceability system for thermocouples, the temperature range of the JCSS has increased, and also the number of JCSS certificates issued by the registered calibration laboratories has increased. The number of JCSS certificates issued was approximately 2000 in FY 2002^[27] while there were approximately 10000 in FY 2008^[28]. It indeed increased five times in these six years. The certifications of standard conformity and calibration values issued by the thermometer manufacturers and the calibration laboratories ensure the reliability of the thermometers used widely in our society.

6.2 Dissemination of the Pt/Pd thermocouples to industry

Research work has shown that the Pt/Pd thermocouple developed as the transfer standard can gain extremely high performance by conducting appropriate heat treatment. In the beginning, this thermocouple was distributed as an R&D product with charge by AIST, and the target was limited to the calibration laboratories that had plans to ask AIST for

calibration. We transferred this technique for fabricating the thermocouple to a private company, thereby enabling a wider range of users to use the Pt/Pd thermocouple. The developed Pt/Pd thermocouple was launched for sale in April 2006 from Chino Corporation to which the fabrication method was transferred^[29].

The Pt/Pd thermocouple is expected to become a thermocouple for general temperature measurement, as well as for a transfer standard. To promote its industrial use, AIST worked on the standardization by IEC, and as an outcome, it was standardized as IEC 62460 in 2008^[30].

6.3 Development of the Pd-C eutectic point

As described in chapter 3, we aim to provide the temperature standards at four fixed points (Ag fixed point, Cu fixed point, Co-C eutectic point, and Pd-C eutectic point) using the Pt/Pd thermocouples as the transfer standards in the future. Therefore, we are currently working actively to develop the Pd-C eutectic point and its evaluation^[5]. We have participated in the joint project (Euromet Project 857) as in the Co-C eutectic point, to conduct the international comparison of the temperature values at the Pd-C eutectic points with the representative European national metrology institutes including PTB (Germany), NPL (UK), and LNE-Cnam (France).

Table 2 shows the projection of how the calibration uncertainties at each temperature fixed point including the Pd-C eutectic point can possibly be reduced in the future. Currently, the metal-carbon eutectic point is not assigned as the defining fixed point in the 1990 International Temperature Scale (ITS-90)^{Term 5}. Therefore, the temperature value using the Co-C eutectic point cell for thermocouple calibration was measured and determined using the radiation thermometer calibrated based on ITS-90. One of the sources of calibration uncertainty of the thermocouple at the Co-C eutectic point shown in Table 1 includes “the uncertainty of the fixed-point device,” and this is the largest uncertainty component of 0.26 °C. This uncertainty component includes the uncertainty of measurement using a radiation thermometer^[6]. In the future, the uncertainty due to the radiation thermometer measurement is expected to decrease, and as a result, the expanded uncertainties (level of confidence of approximately 95 %) of the thermocouple at the Co-C and Pd-C eutectic points are expected to fall to approximately 0.3 °C. When this is achieved, it will be

Table 2 Calibration uncertainty of the Pt/Pd thermocouple at each temperature fixed point expected in the future.

Temperature fixed point	Ag fixed point	Cu fixed point	Co-C eutectic point	Pd-C eutectic point
Temperature of fixed point / °C	961.78	1084.62	1324.0	1491.9
Expanded uncertainty of calibration / °C (Level of confidence of approx. 95 %)	0.09	0.11	0.3	0.3

possible to provide the standards with smaller uncertainty in the temperature range up to 1500 °C using the Pt/Pd thermocouple as a transfer standard.

7 Conclusion – significance of the Measurement Standards Development Program

Since the latter half of the 1990s, AIST/NMIJ has been establishing the traceability system by setting the Measurement Standards Development Program based on the social demand in Japan. Of course, the establishment was done by closely following the trends of our industry. The execution of the 10-year period of the Measurement Standards Development Program started in 2001 is now coming to an end. Throughout this period, when and which measurement standards would be prepared and disseminated by AIST were clearly presented to the companies that place importance on quality control including the calibration laboratories. The system was built by discussing a system for measurement standards that was most appropriate to serve the demands for Japan. This means that the necessity of fusing the technological foundation to ensure the reliability that has been built by industry, and the metrology traceability established by AIST/NMIJ, has been well understood.

The development of the temperature standards is considered to be an excellent example that promoted the use of JCSS^[31]. It was indeed a result of the synchronization of the expanded range of national measurement standards provided by AIST and the vast variety of calibration services conducted by the private companies. This required the integration of the various elemental technologies described in this paper; including the setting of the national measurement standards, the technological development of the transfer standards, the evaluation of uncertainty, the establishment of the quality management system, the execution of the international comparison, the construction of the traceability system, the drafting of the technical documents for calibration, and others. It was a long-term effort that started in the late 1990s, and now, has grown to be a strong system that guarantees the reliability of the temperature measurement up to 1550 °C which has been established in Japan. The authors will continue the technological development for further advancements as described in section 6.3, and will engage in the activities to promote and spread the use of our traceability system.

Acknowledgements

The authors appreciate Dr. K. Yamazawa and Dr. J. V. Widiatmo (Thermometry section, Temperature and Humidity Division, NMIJ, AIST) for their valuable suggestions upon improving the English translation of this paper.

Terminology

- Term 1. Thermocouple: Highly practical thermometer made of two different kinds of metal or alloy wires. It can measure extremely low temperature of -270 °C to ultra high temperature of 2400 °C depending on the wire selected. Currently, the Japan Industrial Standard (JIS) designates eight types: types T, J, E, K, and N thermocouples using base metal; and types S, R, and B thermocouples using noble metal.
- Term 2. Temperature fixed point: Heat equilibrium where the phase transition occurs at constant temperature. The calibration of thermometers is conducted at this point because it has excellent reproducibility and stability. Some well known fixed points are: the triple points of water (the temperature at which gaseous, liquid, and solid phases coexist) and the freezing point of pure metals such as copper, silver, zinc, and others.
- Term 3. Eutectic point: The melting or freezing temperature of alloys when two or more solid phases separate out from a solution and freeze to become a densely mixed substance. The melting or freezing temperature of alloy becomes minimum at the eutectic composition.
- Term 4. Japan Calibration Service System (JCSS): This was started as an accreditation system for the calibration laboratories based on the Measurement Act in November 1993, and became a registration system in July 2005. The calibration laboratory undergoes screening to see whether it fulfills the requirements of the calibration institution standard (ISO/IEC 17025) set by the International Standard Organization (ISO) and the International Electrotechnical Commission (IEC). The calibration laboratory is registered if it meets the necessary requirements. The registered laboratory may issue the calibration certificate bearing the JCSS mark.
- Term 5. The International Temperature Scale of 1990 (ITS-90): The temperature scale that approximates the thermodynamic temperature based on the international agreement among the member state of the Metre Convention. It is defined by the temperature values at several fixed points and the interpolations (interpolation thermometer and interpolation function). The ITS is reviewed approximately every 20 years, and currently, the temperature scale based on the technique available in 1990 is used.

References

- [1] JIS C 1602, Netsudentsui (Thermocouple). Japanese Standard Association, Tokyo (1995) (in Japanese).
- [2] H. Numajiri, H. Ogura, M. Izuchi and M. Arai: Uncertainty evaluation on the freezing point of silver for thermocouple

- calibration, *AIST Bulletin of Metrology*, 4 (1), 741-745 (2002) (in Japanese).
- [3] H. Ogura, H. Numajiri, K. Yamazawa, J. Tamba, M. Izuchi and M. Arai: Uncertainty evaluation on the freezing point of copper for calibration of thermocouples, *Transaction of the Society of Instrument and Control Engineers*, 39 (11), 1016-1021 (2003) (in Japanese).
- [4] Y. Yamada, F. Sakuma and A. Ono: Thermocouple observations of melting and freezing plateaus for metal-carbon eutectics between the copper and palladium points, *Metrologia*, 37 (1), 71-73 (2000).
- [5] H. Ogura, M. Izuchi and M. Arai: Evaluation of Co-C and palladium-carbon eutectic point cells for thermocouple calibration, *Int. J. Thermophys.*, 29, 210-221 (2008).
- [6] H. Ogura, M. Izuchi, J. Tamba and M. Arai: Uncertainty for the realization of the Co-C eutectic point for calibration of thermocouples, *Proc. ICROS-SICE International Conference 2009*, 3297-3302 (2009).
- [7] H. Ogura: 1000 °C ijo deno netsudentsui no choki antei sei no hyokagijutsu (A technique for evaluation of long-term stability of thermocouples at high temperatures above 1000 °C), *AIST TODAY*, 10 (1), 23 (2010) (in Japanese).
- [8] H. Ogura: Dissemination of temperature standard using thermocouple, *AIST TODAY*, 6 (1), 36-37 (2006) (in Japanese).
- [9] R. E. Bentley: Theory and practice of thermoelectric thermometry, *Handbook of Temperature Measurement Vol. 3*, Springer (1998).
- [10] H. Ogura: Temperature sensor using thermoelectric effect, *Journal of the Society of Instrument and Control Engineers*, 45 (4), 306-311 (2006) (in Japanese).
- [11] G. W. Burns, D. C. Ripple and M. Battullo: Platinum versus palladium thermocouples: an emf-temperature reference function for the range 0 °C to 1500 °C, *Metrologia*, 35, 761-780 (1998).
- [12] H. Ogura, H. Numajiri, K. Yamazawa, J. Tamba, M. Izuchi and M. Arai: Effects of heat treatment on the inhomogeneity of the Pt/Pd thermocouple at the Cu freezing point, *Temperature: Its Measurement and Control in Science and Industry*, 7, 485-489 (2003).
- [13] G. W. Burns and D. C. Ripple: Variation in the thermoelectric behavior of palladium following heat treatment, *Proc. TEMPMEKO 2001*, 1, 61-66 (2001).
- [14] H. Ogura: Reliability of Pt/Pd thermocouple at fixed point, *Journal of the Society of Instrument and Control Engineers*, 42 (11), 926-929 (2003) (in Japanese).
- [15] H. Numajiri, H. Ogura, M. Izuchi and M. Arai: Effect of heat treatment on the inhomogeneity of the Pt/Pd thermocouples at the silver freezing point, *Proc. TEMPMEKO 2004*, 1, 477-482 (2004).
- [16] H. Ogura, K. Yamazawa, M. Izuchi and M. Arai: Emf changes of Pt/Pd thermocouples in the range from 1080 °C to 1330 °C, *Proc. TEMPMEKO 2004*, 1, 459-464 (2004).
- [17] M. Izuchi, H. Ogura, H. Narushima, H. Numajiri and M. Arai: Emf changes of Pt/Pd thermocouples in the range 420 °C to 1080 °C, *Proc. TEMPMEKO 2004*, 1, 477-482 (2004).
- [18] F. Jahan and M. Ballico: APMP regional comparison of type R (Pt-Pt13 %Rh) thermocouples from 0 to 1100 °C, *Metrologia*, 44, Tech. Suppl. 03004 (2007).
- [19] R. Morice, F. Edler, J. Pearce, G. Machin, J. Fischer and J. R. Filtz: High-temperature fixed-point facilities for improved thermocouple calibration - Euromet Project 857, *Int. J. Thermophys.*, 29, 231-240 (2008).
- [20] F. Edler, R. Morice, H. Ogura and J. Pearce: Investigation of Co-C cells to improve thermocouple calibration, *Metrologia*, 47, 90-95 (2010).
- [21] M. Arai: Dissemination of standard for temperature, *AIST TODAY*, 3 (4), 34 (2003) (in Japanese).
- [22] National Institute for Technology and Evaluation homepage, <http://www.iajapan.nite.go.jp/jcss/lab/index.html>
- [23] Report of the Joint Experiment including the Calibration of Type R Thermocouples at Pd Fixed Point, Temperature Measurement Subcommittee, under the 36th Committee on Industrial Instrumentation of the Japan Society for the Promotion of Science (2005) (in Japanese).
- [24] M. Izuchi, S. Masuyama, H. Ogura and M. Arai: Inhomogeneity evaluation of type R thermocouples at the palladium melting point, *Proc. SICE 2005*, 1499-1502 (2005).
- [25] T. Hamada, J. Ode and S. Miyashita: An uncertainty estimation of type R thermocouples exposed at Pd fixed point, *Proc. SICE 2005*, 1090-1095 (2005).
- [26] National Institute for Technology and Evaluation: Doc. ID JCT21306, Specific Application Document (Contact Type Thermometer (Thermocouples)) (in Japanese).
- [27] National Institute for Technology and Evaluation: H14-16 nendo JCSS kosei shomeisho hakko kensu no suii (Statistics of JCSS calibration certificates issued in 2002~2004), <http://www.iajapan.nite.go.jp/jcss/pdf/H14-16.pdf> (in Japanese)
- [28] National Institute for Technology and Evaluation: H18-20 nendo JCSS kosei shomeisho hakko kensu no suii (Statistics of JCSS calibration certificates issued in 2006~2008), <http://www.iajapan.nite.go.jp/jcss/pdf/H18-20.pdf> (in Japanese)
- [29] AIST Press Release: Sansoken kaihatsu no koseiyo netsudentsui ga minkan kigyo ni yori jitsuyoka (Thermocouple developed by AIST for calibration commercialized by Japanese private company), March 27, 2006, http://www.aist.go.jp/aist_j/press_release/pr2006/pr20060327/pr20060327.html (in Japanese)
- [30] IEC 62460, Temperature – Electromotive force (EMF) tables for pure-element thermocouple combinations, International Electrotechnical Commission (2008).
- [31] Japan Electric Measuring Instruments Manufacturers' Association: *JCSS No Chishiki – Ondokei No Kosei O Rei Toshite (Knowledge of "Japan calibration service system")*, JAPAN INDUSTRIAL PUBLISHING CO., LTD., Tokyo (2006) (in Japanese).

Authors

Masaru Arai

Joined the National Research Laboratory of Metrology, Agency of Industrial Science and Technology in 1984. Became the chief of Thermometry Section, Temperature and Humidity Division, National Metrology Institute of Japan, AIST in 2001. Currently acts as the deputy director and head of the Temperature and Humidity Division, NMIJ. Engaged in the research of platinum resistance thermometer for high temperature, as well as the development of measurement standard and the confirmation of international equivalence for resistance thermometer and thermocouples. Japanese delegate for the Consultative Committee for Thermometry (CCT), Received the Ichimura Academic Award in 1998. Works on the dissemination of the temperature standard and metrological traceability with the Japan Society for the Promotion of Science and various industrial associations such as the Japan Electric Measuring Instruments Manufacturers' Association. In this paper, was in charge of the development of the fixed-point device and the overall coordination of the research.



Hideki Ogura

Joined the National Research Laboratory of Metrology, Agency of Industrial Science and Technology in 2000. Assigned to the Thermometry Section, Temperature and Humidity Division, National Metrology Institute of Japan, AIST in 2001. Worked at LNE-Cnam, the national metrology institute of France, for one year and four months from 2007, and engaged in research for high-temperature thermocouple and eutectic point. Has worked on the R&D of thermocouples and fixed points. Currently, as the vice-chairman of the working group of the Temperature Measurement Subcommittee, under the 36th Committee on Industrial Instrumentation of the Japan Society for the Promotion of Science, investigates the thermocouple calibration technique and the verification of reliability, in cooperation with the calibration laboratories. In this paper, was in charge of the research of thermocouple stability and the development of eutectic point.



Masaya Izuchi

Joined the National Research Laboratory of Metrology, Agency of Industrial Science and Technology in 1980. Assigned to the Thermometry Section, Temperature and Humidity Division, National Metrology Institute of Japan, AIST in 2001. Worked on the R&D of temperature standard for thermocouples and calibration service. Helps with the assessment and management of JCSS as the technical advisor and the subcommittee member of the technical committee to ensure the reliability of traceability. In this paper, was in charge of the uncertainty evaluation and the establishment of quality management system for thermocouple calibration.



Answer (Masaru Arai, Hideki Ogura, and Masaya Izuchi)

The greatest motivation was to set our minds on tackling the inhomogeneity of thermocouples. As mentioned in the paper, the thermocouple is affected by temperature gradient due to inhomogeneity. Therefore, in other national metrology institutions, there is a limitation tacked on to the thermocouple calibration that the value is applicable only if it is used under the same condition that the thermocouple was tested. But that means the user of the calibrated thermocouple could not use the values as they are. When we started the research, we faced the issue of how to handle the uncertainty evaluation considering that the inhomogeneity caused bias rather than variation, and that this increased with longer exposure to high temperature. We attempted to solve the problem by taking the following procedures: (1) reduce the inhomogeneity of the thermocouple itself, (2) evaluate the inhomogeneity appropriately, and (3) check the adequacy of the evaluation method by having the users submit the temperature distribution data of the calibration device they possess.

The reason we succeeded is, using perhaps an overused phrase, we simply “never gave up and went all the way.” Following the inhomogeneity increase over time is a work that requires endless patience, but one of the factors of success was we developed a highly accurate calibration device and established an efficient and precise thermocouple evaluation method using this device. The precise evaluation to the fine level as we did this time was never done before because it took so much time and effort. Yet now, the evaluations can be done much more efficiently, and we can conduct experiments in many different conditions. As a result, we were able to build a traceability system for thermocouples with exceeding reliability.

2 Factors for the stabilization of Pt/Pd thermocouples

Comment and question (Jun Hama, Evaluation Division, AIST)

Authors clarified heat treatment conditions to reduce the drift and inhomogeneity, which cause the uncertainty sources of calibration of the Pt/Pd thermocouples, and developed uncertainty evaluation method to the establishment of the calibration method. These results are helpful to the development of the transfer standards with high precision and to supply them to industry.

To understand these results more clearly and to consider the possibility of further increasing their reliability, please teach why the drift and inhomogeneity stabilize in the case of the Pt/Pd thermocouples, although the authors described the guidelines for heat treatment conditions to reduce the uncertainties due to these factors. In the type R thermocouples, why don't the drift and inhomogeneity decrease at similar heat treatment temperature?

Answer (Masaru Arai, Hideki Ogura, and Masaya Izuchi)

In Fig. 9(c), only the tendency for increased Seebeck coefficient is presented schematically, but in case of the Pt/Pd thermocouple, there are temperature ranges where the Seebeck coefficient may become large or small by exposure to the temperature range from room temperature to 1300 °C. Therefore, by conducting preliminary heat treatment for sufficiently long time at an appropriate temperature, the change in the integral value of the electric field generated in the wire along the thermocouple can be kept very low. Moreover, in the Pt/Pd thermocouple, the change in the Seebeck coefficient due to exposure tends to become saturated over time, and the emf ultimately stabilizes. On the other hand, in the type R thermocouple, the composition of the Pt-Rh alloy continues to change at around 1000 °C. Therefore, the Seebeck coefficient continues to decrease without saturation, and as a result, the drift does not become saturated and the emf continues to decrease.

3 Microscopic factors for the instability of the Pt/Pd thermocouple

Discussions with Reviewers

1 Motivation of the research

Comment and question (Akira Ono, AIST)

This paper describes excellent *Type 2 Basic Research* and *Product Realization Research* where the traceability system for the thermocouples in Japan was designed from a bird's-eye perspective, various elemental techniques were integrated while developing a new elemental techniques, and the traceability system acceptable by society was constructed, all while working with the international movement. Since the many thermocouples are commonly used the social and industrial effect of the increased reliability of the temperature measurement is immense.

One issue, the engineers mainly of the iron and steel manufacturing industry have often indicated that there are some serious problems in the reliability of thermocouples at high temperatures. On the other hand, thermocouples have been generally used as thermometers for a very long time, and some have said that there might not be no more room for advancement, and the research in Japan has not been active. With this background, I am quite surprised the authors sought a new research subject in the thermocouples, and were able to construct a traceability system for thermocouples with exceedingly high reliability. What was your motivation for starting this research, and what do you think was the factor of success? Can you please reply based on your experiences as researchers who were directly involved.

Question (Akira Ono)

That the drift and inhomogeneity can be significantly reduced by final heat treatment of the Pt/Pd thermocouple at a specific temperature is a major finding of this research. The authors stated that the cause of drift and inhomogeneity is in the palladium wire, but palladium is pure metal, and I don't think its composition changes by exposure to high temperature. I suppose the cause of decreased drift and inhomogeneity may be some suppression of microscopic structural change in the palladium wire, but what is the view of the authors? To what extent can the microscopic changes that occur in the palladium wire be explained in terms of material science and solid state physics?

Is there any other way than maneuvering the heat treatment condition based on some different principle that can reduce the drift and inhomogeneity of the thermocouple?

Answer (Masaru Arai, Hideki Ogura, and Masaya Izuchi)

We are certain that the microscopic structure change of the palladium wire has something to do with this. Currently, other researchers report the cause of the drift and inhomogeneity of the Pt/Pd thermocouple, and these can be roughly divided into: the oxidation of the impurities in the palladium wire, and the growth of crystal grain in the palladium wire.

If the cause is the impurities in the palladium wire, the impurities in palladium oxidize, and change from conductor to insulator, thereby changing the emf. Therefore, if the refining technique advances in the future, and we are able to fabricate highly pure palladium wire or remove the impurities that enhance the inhomogeneity, then we may be able to inhibit the inhomogeneity. On the other hand, if it is caused by the growth of crystal grain in the palladium wire, we can sufficiently grow the crystal by preliminary heat treatment, or add additives to inhibit the crystal growth to the level that it will not alter the emf.

Currently, the cause of the drift and inhomogeneity of the Pt/Pd thermocouple is not fully clarified, and to further reduce the calibration uncertainty of the thermocouple is a future research topic.

4 Contribution to the Japanese industry and its level

Comment and question (Akira Ono)

The authors established the traceability system for thermocouples with thorough consideration of the technological status of the Japanese industry. I think there is a Japanese characteristic in the traceability system compared to the that in other countries. Many of the Japanese private calibration laboratories possess fixed-point furnaces of high temperatures that can be used for calibration services, though the furnaces may not be advanced like the AIST's national measurement standards. The authors took into account the equipment and experiences of the private calibration laboratories, and I think that it is the reason the authors were able to construct a traceability system at the highest level of reliability in the world. What do you think about that point? The authors repeatedly emphasize "the technique that has been nurtured by the private companies" in the paper and I wonder whether you are referring to this.

It was demonstrated by the international comparison that the technological level of AIST is high. If there was an international comparison among the I suppose the Japanese calibration laboratories would perform extremely well. What is your thought? I would suggest some activities so that the high technological reliability of the Japanese private calibration laboratories are recognized better in the world.

Answer (Masaru Arai, Hideki Ogura, and Masaya Izuchi)

In Japan, the introduction of the fixed-point device to raise the reliability of temperature measurement started early. Also, for the thermocouple calibration device using the Co-C eutectic point, which is our latest research mentioned in the paper, the Japanese calibration laboratories have developed products jointly with AIST, and several laboratories are already preparing to use these devices. As you can see, the technological level of the Japanese calibration laboratories is extremely high. If there is an international comparison among the calibration laboratories, the Japanese laboratories will certainly demonstrate high reliability. Also, in the working group of the Temperature Measurement Subcommittee, under the 36th Committee on Industrial Instrumentation of the Japan Society for the Promotion of Science, the thermocouple calibration laboratories and AIST are collaborating to study the thermocouple calibration technique, and we would like to present the research results at international conferences.

5 Reliability of the thermocouples at temperatures above 1550 °C

Question (Akira Ono)

This paper describes the traceability system of thermocouples in the temperature range up to 1550 °C. Thermocouples are also used as the major thermometer for above 1550 °C. What do you think is the reliability of the thermocouples in this temperature range? If you were constructing the traceability system in the temperature range above 1550 °C in the future, what kind of research approach would you take?

Answer (Masaru Arai, Hideki Ogura, and Masaya Izuchi)

The thermocouple is a major thermometer for high temperatures above 1550 °C. In industry, tungsten-rhenium thermocouples are used for temperatures up to over 2000 °C. However, in practice, the reliability of tungsten-rhenium thermocouples are not really known. For example, with approximately 100 hours of use, approximately 5 °C thermoelectric drift is expected at around 1700 °C, and the drift will increase in higher temperatures.

In this temperature range, it is difficult to create a stable and homogeneous temperature field to begin with, and in addition, since the reactivity of the substance increases, the effect of the insulation and protection tubes on the thermocouple wire must be studied. To construct highly reliable thermocouple traceability, we think it is important to engage in R&D to solve the elements for evaluating the stability of the thermocouple. We would like to continue the research by actively incorporating the high reproducibility of metal-carbon eutectic point that is the result of our latest research.