

Optical Information Technology

**Optical Technology that Supports
the Rapidly Growing Information Society**



*National Institute of
Advanced Industrial Science
and Technology*

AIST

Optical Information Technology

— Optical Technology that Supports the Rapidly Growing Information Society

Overview—Science & Technology, Information, Light

Introduction

The words, “image” and “ubiquitous”, are keywords for the future field of information. In order to build a society where high definition images and moving images can be freely used, and where information can be used without restriction of time or place, it is necessary to expand communication and storage (memory medium) to a higher capacity and to develop devices that innovate displays and information tags. Articles in this brochure present the research and development of optical information technology being done at AIST. Here, in this article, is given a broad overview of the characteristics and placing of light.

Characteristics of light

Light has many characteristics that are useful. Among them are the abilities to bring to us most of the energy from

the sun, to do noncontact measurement and material handling at a considerable high resolution and high density level, to transmit information at high speed, and the fact that it has an additional degree of freedom of wavelength (color). By using these characteristics, optical communication devices / systems, information storage devices, solar cells, measuring instruments, processing machines, displays, cameras, and DVDs are realized.

As can be seen, light is used in various places, but here, we will look at the role that light plays in the informatization of society which is advancing at great speed. The figure shows an image of the role that light plays in society.

Science & technology, information, light

A large goal of science & technology is to enrich human life. If one briefly looks

back over history, man has put much effort into making life convenient and rich. First, man made tools and machines for manual use, and then automated them. He made fire manageable, and has acquired and made many chemicals. Furthermore, he has acquired electricity, magnetism and electromagnetic wave, and then, computers and telecommunication appeared. Based on these, with the introduction of the digital concept, a new value called “information” appeared. Information, of course, has been in existence from ancient times, but it is only in recent history that it was given a proper name and became a large, independent concept separated from “objects”, and became a large-scale technological field.

As the world of information is abstract and free of physical existences as “objects”, it grew rapidly. The most convenient aspect that information

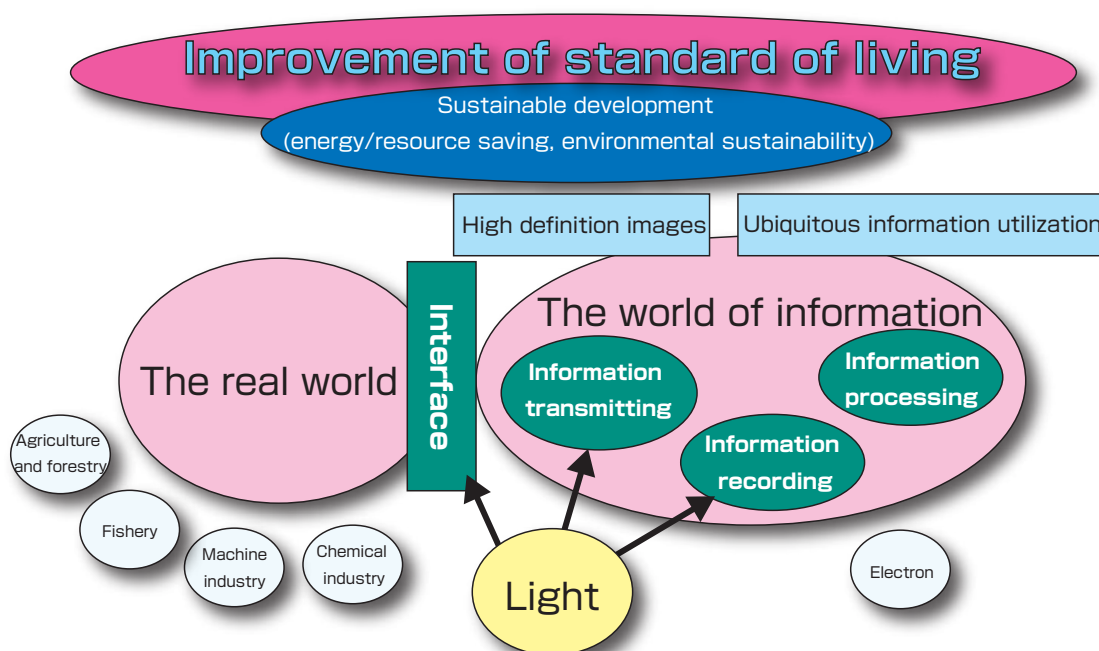

Image of the role of light in information-oriented society



technology brings about is that new data can easily be produced and processed (data processing), stored (recording), and be carried far at high speed (transmission). The fundamental technologies of the field of information are these three. In addition to these, in order for man to use information, technology that functions as interface between the world of information and the real world through an “object” medium is needed.

Optical technology is an important basic technology that supports an information-oriented society which is expected to grow rapidly, and of the four aspects, it executes strength in transmission, recording and interface. This is demonstrated in optical communication which transmits large quantity of data at high speed, in optical disks which can store large quantity of data compactly and which are portable, and in cameras and displays which can acquire and show high definition images.

Let us look at one example. An important aspect of informatization in recent years has been the development of the Internet, and, in these few years, the amount of data flow has increased rapidly at an annual rate of over 40 %. The reasons for this are the increase of image data, the move toward higher definition and the increase in moving images, and this tendency is going to accelerate in the future. The biggest channel by which man acquires information is through the eye, and to be able to freely use image data which appeals to the eye will greatly change the activities of mankind. If technologies for processing, recording, transmitting, and displaying high definition images, moving images,

and 3D images are realized, and if the images attain a high level of realistic sensation as if one is actually there, then TV conferences, remote medical care and remote education will definitely become usable. If this level is achieved, then it will expand the virtual activities of mankind. In order to realize this kind of society, it is essential that massive improvement is made in large capacity optical communication and optical recording, in high definition and large screen displays, and in devices and material technology.

Sustainable development

As the influences of science & technology and industry that uses them increase, and as the human activities expand, there are growing concerns that “sustainable development” may become difficult. At AIST, we aim to solve this problem and claim a basic principle “to contribute to the realization of a sustainable development of the society of the earth by leading the steady industrial technological innovation of our country”. Formerly, we could make our lives better by “consuming” resources and energy of the earth, but from now on, we need to restrain and dissolve the negative side as well as make advancements at the same time.

Information technology intrinsically has the possibility of improving living standards with low consumption, and can contribute greatly to improving efficiency in such hardware areas as machinery, chemical, and manufacturing industries. For example, a large part of experiments and trial manufacturing before making

the final product, can be replaced with computation. The reason for the slow spread of TV conferences, remote medical care and remote education is thought to be the lack of a sense of reality. If we can solve this by further enlarging the capacity of communication and by realizing large screen displays, it will greatly reduce the movement of people. Optical technology can contribute greatly to the development of these areas.

Conclusion

In this brochure, the research activities for large capacity optical communication and recording, and devices for flexible displays being done at AIST are introduced. These technologies contribute to the handling of high definition images and moving images, ubiquitous information utilization (free of time or place), and saving energy and resources.

With information technology which makes rapid advancements, there is always the concern for changes that are beyond human assessment or control. There is a need to control and eliminate the negative aspects as well as to develop the technology. With all this in mind, we will continue the research and development of optical technology that supports the progress of an information-oriented society, and would like to contribute to the sustainable development of mankind.

Director
Photonics Research Institute
Masanobu Watanabe

Concept of Optical Path Network

The future of the increase of network communication

The Internet is an indispensable part of our lives. The amount of communication through the Internet is increasing at an annual rate of 40%. Can it continue to increase forever? Fig. 1 shows the future estimation of network communication amount and power consumption of routers. The black and red dots are based on government survey data, and the actual lines are extrapolated from the observed annual increase rates. What can be seen from the figure is that the total router power consumption increases as the communication volume increases, and it took up about 1% of the total electric power supply in 2006. This means that to enable 100-times increase of communication load in the future, the power consumption of the router needs to become 100% of the total electric power supply. The router, of course, will become more highly efficient in the future, but nevertheless, the present technology will face limit.

On the other hand, looking at the

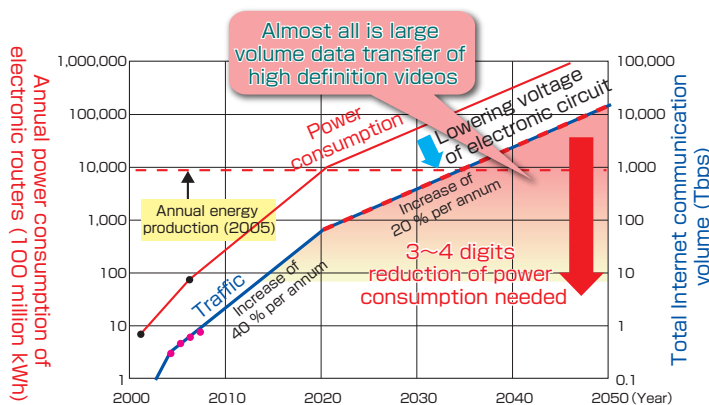

Fig. 1 The Internet communication volume and the increase of power consumption of the routers

transition of network related technology as the cause of increase in communication volume, one can see that the use of network has moved from the telephone (voice) to data communication, and is presently shifting toward video contents (Fig. 2). It is thought that super high-definition imaging technology such as super hi-vision^[1] will be widely used in the future. Then, the concept of “remote co-existence” through the network will become possible, and most of the activities that were done by meeting in person will be able to be done at a distance. For example, 24 hour sharing of space information through a screen which occupies the entire wall of a living room will make “distant living together” situation become technologically feasible.

Optical path network expected to increase energy efficiency by several digits

We need to create a network technology that can handle volumes larger by several digits with which we can easily exchange high definition videos, without increasing energy consumption. Looking at Fig. 2,

one can see that the granularity per user (unit of data volume processed by a user through the network) is changing from digital packet to optical fiber line (or optical fiber path). Keeping this in mind, we are focusing on optical path network or an optical circuit switching system which switches optical fibers/paths. As can be seen in Fig. 3, compared to existing packet switching, if only considering node processing, optical path network which switches optical fibers/paths with optical switches can save energy by 3, 4 digits.

There is no other low-power technology that is as simple and that has large potential as this. However, optical path network is not a packet switching network as the existing one but a circuit switching one. Fig. 4 shows the difference between data transfer between computers, and transfer of a live image of a person. Simply said, packet switching is suitable for the former, whereas circuit switching is suitable for the latter. As the network handles both data and videos, the packet switching and the circuit switching are complementary.

		Data		Video	
Application viewpoint	Band occupancy application	Email WWW	P2P YouTube	IPTV TV conference/telephone	Remote co-existence telepresence
	High-definition video resolution / band	SD 0.2 Gbps	HDTV 1.5 Gbps	4 k 20 Gbps	8 k(SHV) 72 Gbps
Network viewpoint	Storage	CD 700 MB	DVD 9 GB	Blu-ray 50 GB	Multi-layered / near field optics?
	Year	1990's	2000's	2010's	2020's
Network viewpoint	Traffic	0.01	1	> 100	> 1,000
	Per user Ethernet I/F	100BASE-T	1000BASE-T	10G-BASE-T	100G?
	Access connectivity	Dial-up	ADSL/Cable	PON-FTTH	Dedicated connections
	Granularity per user	Voice 10 kbps	Twisted pair 1-10 Mbps	Sub-wavelength to wavelength > 100 Mbps	Wavelength to Fiber > 10 Gbps
Type of network	Telephone	Internet	NGN/ROADM	Dynamic optical path network	

Fig. 2 Transition of network services and related technologies

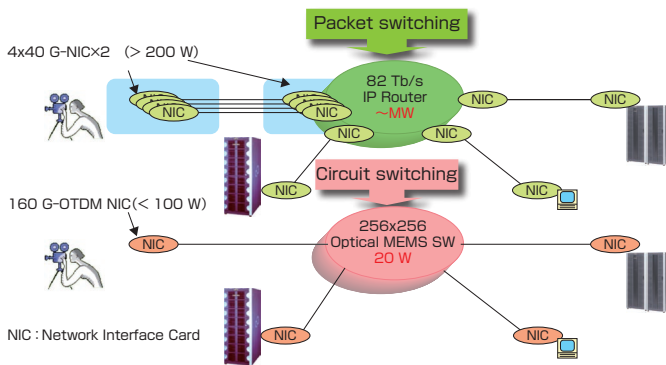

Fig. 3 Packet switching and optical circuit switching

Service	Data-based (PC)	High-definition video-based (person)
Data size	Few bits to tens of MBs	Huge (hundreds of terabytes)
Size variance	Large	Relatively small
Transfer delay fluctuation	Relatively tolerant	As little as possible
Call blocking	As few as possible	Acceptable as busy line
QoS	Depending on situation	important
Suitable network mode	Connectionless packet switching	Connection-oriented circuit switching

Fig. 4 Data and video-based service suitable network mode

Therefore, we think that it is appropriate to do research and development to establish an optical path network parallel to the existing packet switching networks. Fig. 5 shows the total view of the framework concept and the enabling technologies.

AIST as a center for optical path network technology

The key enabling technologies for optical path network such as optical switch, high-speed interface, optical amplifier and dispersion-managed transmission line have already been put to practical use. However, to use optical path network “anytime, anywhere, freely, by anyone”, a massive deployment of fiber will be necessary, and the existing hardware technology is almost totally useless in scale, volume, cost and size. A new technology is needed which will enable further integration, mass production and cost reduction in fundamental devices. Moreover, even if the hardware technology matures, there is a need to develop various kinds of software depending on how the network is going to be used.

It is vital to look over from applications to fundamental devices and discuss/envison the best new network architecture, and to set

the goal of individual enabling technology. In this context, especially related to optical technology are optical path interface technology such as network interface card (NIC) which physically connects optical path and applications, optical path management and control technology such as middleware which autonomously optimizes the optical path settings upon users’ requests, optical path switching technology such as optical switch which physically switches over optical paths, and optical path conditioning technology such

as an autonomously controlled tunable dispersion compensation device which enables optical signals to be transmitted correctly when optical path switches. AIST, while aiming to become a “vertically integrated center for optical path network technologies” in collaboration with external companies and research institutes, will continue to do research and development of these enabling technologies^[2].

Ultrafast Photonic Devices Laboratory*
Shu Namiki, Toshifumi Hasama

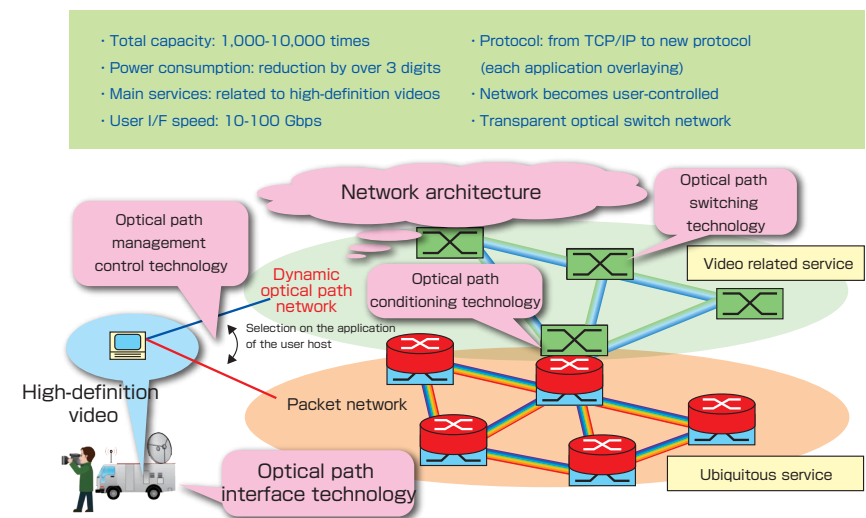

Fig. 5 Dynamic optical path network deployed parallel to packet network

References

- [1] <http://www.nhk.or.jp/digital/en/superhivision/>
- [2] S. Namiki: *AIST TODAY*, 8 (4), 26-27(2008).

* Present Network Photonics Research Center

Ultrafast Optical Semiconductor Switch

Introduction

In recent years, the information communication volume starting with the Internet is increasing rapidly. There is an urgent need for a photonic network which makes large volume, high speed communication possible. At present, to realize large volume optical communication, efforts are made to increase the number of channels, as well as to accelerate the transmission speed per channel; however, when the transmission speed exceeds 160 Gb/s (gigabit/second) per channel, it is thought that, because of the speed limitations of electronic devices, it is difficult to continue using electric circuits to process transmit-receive signals. Therefore, in processing signals over 160 Gb/s, it is necessary to process at ultra high speed without converting light signals to electrical signals. To realize this, the development of an ultrafast optical switch is the key.

An all-optical switch using intersubband transition of quantum wells has ultrafast response of a range of picosecond to subpicosecond, and is regarded promising as an ultrafast optical signal

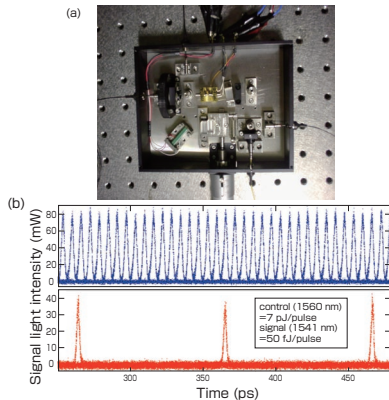

Fig. 1 (a) An interferometer optical switch module that uses all-optical phase-modulation of InGaAs/AlAsSb quantum well (b) Pulse train separation from 160 Gb/s to 10 Gb/s
*top 160 Gb/s light separation multiple signals
*bottom Signals after 10 Gb/s pulse separation

processing device. We, at the Ultrafast Photonic Devices Laboratory, are developing InGaAs/AlAsSb III-V group semiconductor quantum well phase-modulating optical switch which operates at 100 Gb/s-640 Gb/s and CdS/ZnSe/BeTe II-VI group semiconductor quantum well absorption-saturating optical switch which operates at an ultrafast speed of over 1 Tb/s (terabit/second).

Phase-modulating optical switch

Recently, with InGaAs/AlAsSb III-V group semiconductor quantum well, we have discovered an all-optical phase-modulating effect based on a totally new principle^[1]. With optical switches, usually the control light and signal light are set at the same TM polarization. Therefore, there was a drawback that even the signal light attenuates due to light loss from intersubband transition absorption. However, with the newly discovered phase-modulating effect, it has the characteristic of even operating with TE polarized wave which does not have absorption loss. If this phase-modulating effect is used, by taking an interferometer framework, a low-loss ultrafast all-optical switch can be realized in principle. We have succeeded in demultiplexing of 160 Gb/s signal to 10 Gb/s with this switch (Fig. 1)^[2]. Presently we are developing a device for multiple separation of 160 Gb/s to 40 Gb/s to be used as optical switch of an ultrafast optical transceiver being developed under the NEDO project "Next-generation High-efficiency Network Device Technology".

Absorption-saturation optical switch

In order to realize an optical switch of ultrafast optical signal of even higher speed of 1 Tb/s, the response speed of materials is the key. In the case of intersubband transition switch, the response

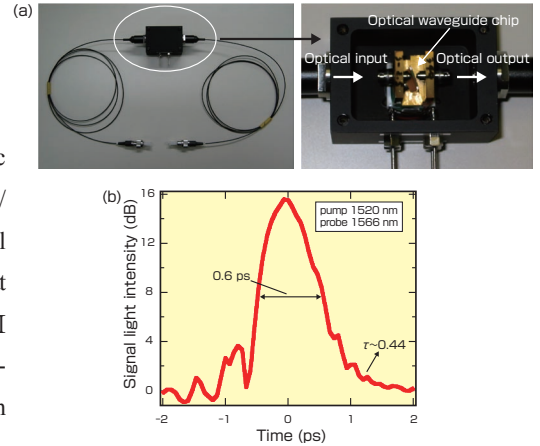

Fig. 2 (a) Absorption saturation optical switch module of CdS/ZnSe/BeTe quantum well. (b) Response to short pulse; ultrafast response of less than 0.6 ps can be confirmed.

speed is determined by the rate that electrons are scattered by longitudinal optical phonon. With II-VI group semiconductor which has strong ionicity, the scattered rate is larger than III-V group semiconductor, and a carrier relaxation of subpicosecond is predicted. As a material, we are doing research of CdS/ZnSe/BeTe quantum well which has a carrier relaxation time of less than 0.5 ps which is of the fastest level of the world. If a strong TM polarized optical pulse is added, the quantum well will become transparent with the absorption saturation effect. We have realized an ultrafast all-optical switch by using this effect. Fig. 2 shows the response wave form to a short pulse. An ultrafast time response of less than 0.6 ps can be confirmed. With this, an optical switch of 1 Tb/s level can be realized^[3]. Presently the biggest problem is operating at low-energy, and we are developing an element device that can take an extinction ratio of over 10 dB at 1 pJ.

Ultrafast Photonic Devices Laboratory*

Ryoichi Akimoto

References

- [1] H. Tsuchida *et al.*, *Opt. Lett.*, 32, 751 (2007).
- [2] R. Akimoto *et al.*, *Appl. Phys. Lett.*, 91, 221115 (2007).
- [3] G. W. Cong *et al.*, *Optics Express*, 15, 12123 (2007).

* Present Network Photonics Research Center

Optical Signal Processing Technology

Introduction

Optical communication technology is expanding from a simple point-to-point transmission to a network configuration that contains a number of nodes (repeaters). A network node fulfills such functions as path switching, monitoring and regeneration of signals, and gateway interconnecting networks of different bit rate and modulation format. These processes are mainly performed using electronic circuits, which causes problems concerning the limitation of operating speed of electronic devices, and the increase of energy consumption resulting from the optical/electrical/optical (O/E/O) conversion. In order to efficiently distribute large volume contents such as high-definition video, it is necessary to construct a node that can perform high-speed data signal processing in the optical domain, without relying on electronic circuits. Optical signal processing is a basic technology to realize such a network node, and a typical research activity conducted at the Photonics Research Institute is presented below.

Optical signal regeneration

Since digital optical signals are degraded during transmission and various processing leading to bit errors at the receivers, there is a need to regenerate the signals by

eliminating the various noise at the network node. This type of signal processing is called 3R regeneration (Re-amplification, Re-timing, Re-shaping), and is currently performed by electronic circuits, using an equipment called transponder.

We have developed an optical 3R regeneration technique that can process optical data signals without relying on O/E/O conversion. Fig. 1 shows the schematic of the optical 3R regeneration equipment. Re-amplification is performed using the optical fiber amplifier. Re-timing is a process that extracts reference clock signals at the frequency corresponding to the data signal bit rate by eliminating modulation and noise components from the incoming optical data signals. Then, the extracted optical clock signals are input to the ultrafast optical gate switch, which performs waveform re-shaping by switching the optical clock signals according to the incoming optical data signals. We have developed a regeneration technique for 40-Gb/s optical data signals by combining the optical clock extraction using an injection-locked optoelectronic oscillator and the semiconductor optical amplifier-based optical gate switch. Fig. 2 shows the bit error rates of the optical data signals obtained in the experiments. Optical 3R regeneration is achieved with

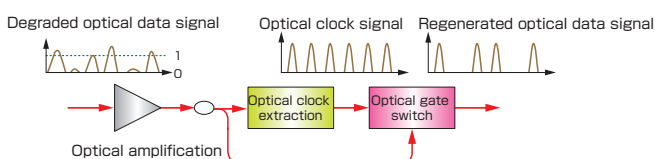

Fig. 1 Schematic of optical 3R regeneration equipment
Regeneration of the optical data signals degraded during transmission and processing is performed through optical amplification, re-timing by optical clock extraction, and re-shaping by the optical gate switch.

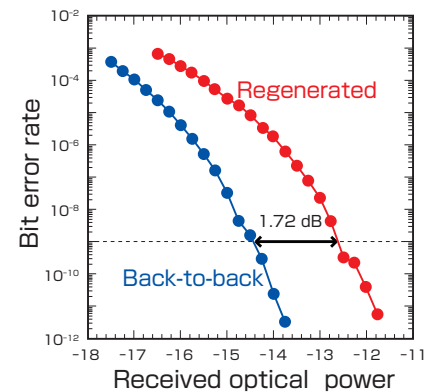

Fig. 2 Bit error rate for 40-Gb/s optical 3R regeneration

Error-free operation was achieved with the power penalty of 1.72 dB at the bit error rate of 10⁻⁹.

a power penalty of 1.72 dB as compared with the back-to-back operation. Also, we confirmed operation at 160 Gb/s using a similar equipment. For improving the quality, stability and reliability of regeneration, and for reducing the energy consumption, it is necessary to enhance the performance of each device such as optical gate switches with hybrid integrated configuration.

Future prospect

The ultrafast optical signal processing technology introduced here can treat digital optical signals with on/off modulation of optical pulses. Recently, new transmission systems have been introduced that employ advanced modulation format such as phase and multi-level modulation. The development of optical signal processing technology for such complex modulation format signals is strongly demanded in the future, and we are planning to promote research and development on this subject in addition to ultrafast optical signal processing.

Photonics Research Institute

Hidemi Tsuchida

Super-RENS Optical Disc

Evolution and limit of optical discs

Optical discs which started from CDs have rapidly become popular in the progress of information-oriented society, have advanced from DVDs to Blu-ray discs, and have continuously handled the explosive increase of data volume (from sound to images). Moreover, not only the ROM (read only memory) discs but also the write-once type and the rewriteable type discs have been developed, and they have become indispensable in our life.

In these optical discs, all information has been digitalized. For example, digital information is carved as a pit (minute concave) in ROM discs. Therefore, the increase of the recording capacity that led from CD to DVD and to the Blu-ray discs was achieved by improving the recording density. The size of a minimum pit that is 870 nm in CD reduces to 400 nm in DVD, and is reduced to 150 nm in Blu-ray discs.

The readout of the recorded information is done exposing the pits with focused laser beam and detecting the change of reflected light intensity according to the presence or absence of pits. Between the focus spot size of laser light and the minimum readable pit size, there is a limitation given of resolution limit = $0.25 \times \lambda / NA$ (λ : wavelength of laser light, NA: numerical aperture of lens). In other words, spot size is defined by wavelength and numerical aperture, and in order to readout a smaller pit, a smaller spot is needed. Therefore, 780 nm wavelength, NA 0.45 of optical system is used for CDs, 650 nm wavelength, NA 0.6 for DVDs, and 405 nm wavelength, NA 0.85 of optical system is

used for Blu-ray discs.

However, this improvement technique of the capacity of data of these optical disc has come to a limit. With the improvement of fine processing technology, it has become possible to make smaller pits of less than 100 nm, but the optical system is reaching its limits. The numerical aperture is reaching the physical limit (NA=1). Therefore, the spot size reduction can only be done with short wavelength. Optical components such as lens and the material of the disc need to be reviewed to use shorter wavelength, and the development of a system that uses the ultraviolet semiconductor laser is becoming necessary. With optical discs of general use, Blu-ray discs (resolution limit: 120 nm) are said to be the limit of high density level in the present system.

Presently, to respond to demands for development of larger capacity optical discs needed in advanced information-based society, the constructing of new optical memory systems (hologram and 2 photon absorption memory) and the development of technology that breaks the resolution limit by using near-field light are needed. Here, ultra high density disc called Super-RENS which is being developed is presented as a way to overcome the resolution limit and to realize high density recording while using the conventional system.

Super-RENS

Super-RENS means super-resolution near-field structure, and is a technology that is totally original of AIST. This, as shown in Fig. 1(a), is a structure that arranges a nonlinear functional thin film sandwiched between thin dielectric films (sandwich structure) in the adjacent region of data recording layer (several tens nm). Its important feature is that the gap between the data recording layer and this nonlinear functional thin film is made by a solid material (thin film). With ROM discs, as shown in Fig. 1(b), this sandwich structure is directly attached to the disc surface with recording pits. When optical discs of this structure are exposed to focused laser light, the interaction between the local change of focus spots caused by nonlinear phenomenon and minute pit that cannot be read normally can be readout as intensity change of reflected light intensity (near-field effect). This near-field light, unlike normal light that propagates in free space, is not transmittable and is a field that only exists in the near a region of approximately 1/10 wavelength. This near-field light can detect minute changes without being influenced by the diffraction limit.

The development of Super-RENS optical disc started with first-generation^[1] which used Sb as nonlinear thin film, then moved to

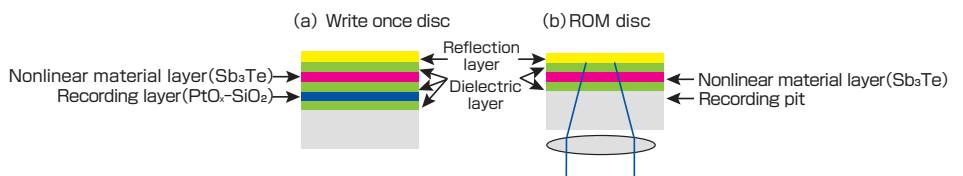

Fig.1 Structure model of Super-RENS optical disc

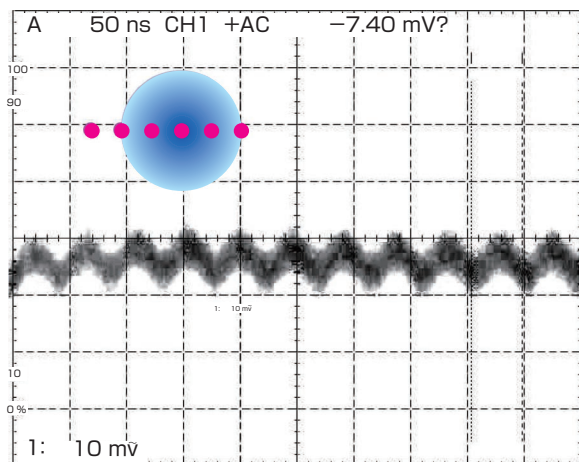

Fig. 2 Measurement results of readout waveform of 50 nm pit train

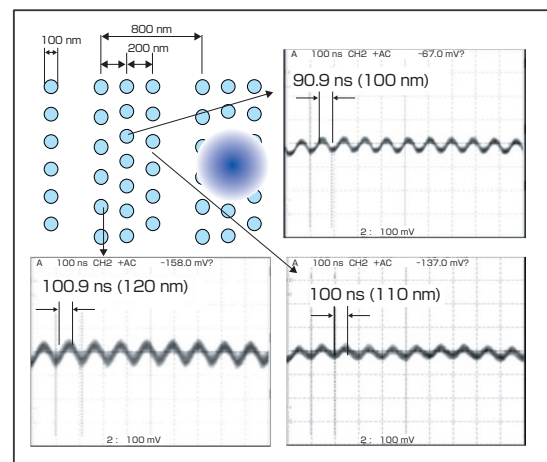

Fig. 3 Narrow track model and its readout results

second-generation^[2] which used AgO_x , and has advanced to the present third generation^[3] which uses phase change material as nonlinear layer. The nonlinear reactions of these materials show high threshold level against laser light intensity for readout, and they react only at the laser focus spot. By using the sandwich structure, the reactions show reversibility. In order to realize a write once optical disc, it is necessary to form minute pits, and we have realized this by using materials such as PtO_x .^[4,5]

Characteristic of Super-RENS optical disc

Fig. 2 shows the readout results of ROM disc that has 50 nm pits. As this readout was done by a disc tester that has optical system of 405 nm wavelength, NA 0.65, it shows that the readout pit size is 1/4 of normal readout pit size (1/3 of the resolution limit) and that it has succeeded in direct observation of waveform. Furthermore, in evaluating a write once disc which uses the Blu-ray disc optical system, it is possible to record and to readout at 37.5 nm mark^[6].

Moreover, this Super-RENS has a super-resolution characteristic in the radial direction of discs. Therefore, it is possible to realize

high radial density of optical discs. Fig. 3 shows the test patterns used in evaluation and the observed results. The normal track pitch of the evaluation system is 400 nm, however, the figure shows that it can separate and readout single pit train from three pit trains with 200 nm track pitch. We are also suggesting a new tracking method, named group track, which increases the radial density to 1.5 times as a way to control spots to tracking pit trains with such narrow track discs^[7].

From these results, by using Super-RENS, it is possible to achieve a high density level of 4 times in linear density, 1.5 times in radial direction, and a total of 6 times overall, and if this method is applied to Blu-ray discs, it is possible to attain 150 GB/layer. Furthermore, if this is incorporated in two-layered discs which are already in practical use, 300 GB becomes possible, and with technology for six-layered discs which has been demonstrated in research, 900 GB becomes possible.

The future

Super-RENS optical disc is being developed as the next optical memory to follow Blu-ray discs with technology which realizes larger volume with the same characteristics as optical memory. We will continue our efforts to improve the characteristics and will aim to establish basic technologies for the realization of large volume processing. At the same time, we will further collaborate with industry to realize an optical disc system with technologies of AIST at the core.

We will also like to expand the various technologies realized through Super-RENS optical disc development as nanostructure formation technologies, and develop nano-optic devices and sensors.

Center for Applied Near-Field Optics Research

Takashi Nakano

References

- [1] J. Tominaga *et al.*, *Appl. Phys. Lett.* 73, 2078 (1998).
- [2] H. Fujii *et al.*, *Jpn. J. Appl. Phys. Part 1*, 39, 980 (2000).
- [3] T. Kikukawa *et al.*, *Appl. Phys. Lett.*, 81, 4697 (2002).
- [4] T. Nakano *et al.*, *Jpn. J. Appl. Phys.*, 44, 3350 (2005).
- [5] T. Shima *et al.*, *Jpn. J. Appl. Phys.* 46, 3912 (2007).
- [6] T. Shima *et al.*, *Jpn. J. Appl. Phys. accepted*.
- [7] K. Kurihara *et al.*, *Jpn. J. Appl. Phys.*, 46, 3898-3901 (2007).

Flexible Device

Experiments to make transistors, memories, and displays using a printing method have begun. The components are made, not of hard, fragile material as silicon, but of soft, light, organic/polymeric material.

Development of flexible devices

Since 2007, there are 11 inch TVs and mobile phones labeled organic EL on market. These use the principle of electroluminescence *i.e.* lighting by passing charge carriers through very thin films of organic dyes as semiconductive materials. Compared to liquid crystal displays (LCD) and plasma display panels (PDP), the screens are much thinner (the thinnest part is 3 mm thick), and the images are clearer (excellent color reproducibility and high contrast ratio of over one million fold), and sharp (fast response time of microseconds). Devices with these characteristics were possible with the use of organic material which is essentially the same as coloring pigments used in paintings and decorations.

There are some organic materials that allow the flow of electricity. These are

materials that have been developed from the achievements of the research by which Hideki Shirakawa, professor emeritus at the University of Tsukuba, won the Nobel Prize in Chemistry in 2000. When these materials were first discovered, the electrical characteristics (charge carrier mobility) were as low as 10,000th to 1 millionth of that of inorganic semiconductors as silicon. Recently, however, materials such as single crystals of organic compounds of condensed benzene rings (as pentacene and rubrene) have been found which have the same level of mobility as polycrystalline silicon. Various conductive polymer materials whose molecular structure is optimized for appropriate self-assembly have been also developed, which show mobility as high as that of amorphous silicon. Compared to silicon, these new materials

are soft and do not break when dropped, and in fabrication, unlike lithography that needs vacuum chamber and many time-consuming processes, they can be printed to form a film in one lot on a large surface, and there are high expectations for such organic devices.

Here are presented materials and processes to make such devices as organic thin film transistor (TFT) and memories by forming a film of dielectric polymers and organic semiconductors on plastic sheets.

Development of printable electronic material : to make into ink

With electronic devices as transistors, not only semiconductors but various materials are needed, such as wiring, electrodes, dielectric material for condenser (capacitor), and insulating material for layer insulation. These various members are made into ink, and are used to form a fine pattern by ink jet printing and screen printing methods. With conductive and insulating materials, it is necessary, however, to improve and stabilize the characteristics by sintering. To use flexible plastic sheets, the sintering temperature must be kept under 150 °C. We, at AIST, have succeeded in developing a special insulating ink that can be sintered at low temperatures, and

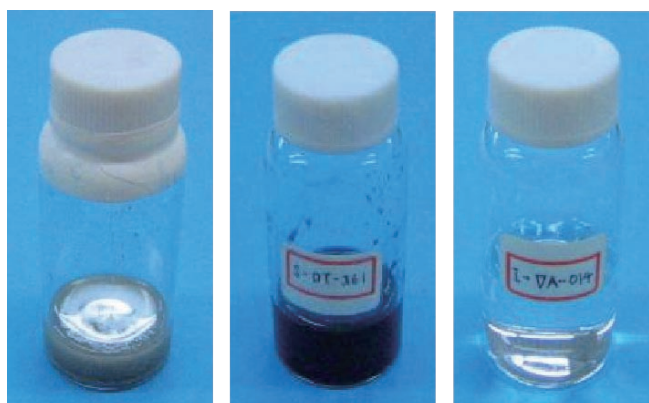

Fig. 1 Conductive ink Organic semiconductor Insulating ink

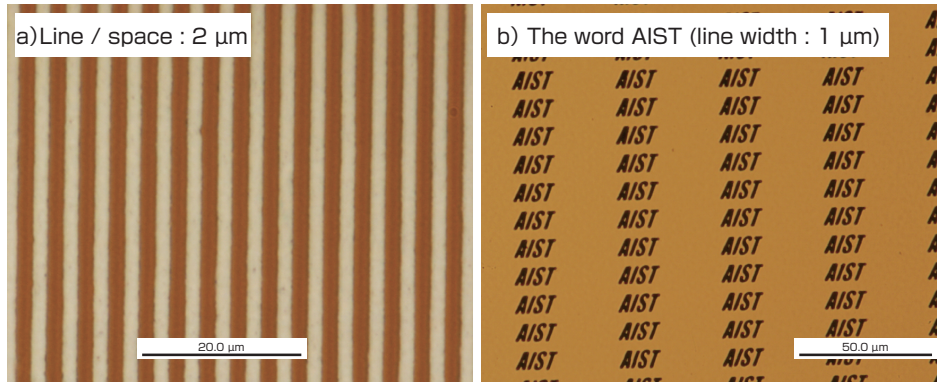

Fig. 2 Fine pattern of silver nano-particles

also have successfully found a process to form wire patterns in low temperatures (Fig. 1).

Printing technology of fine patterns: nano-printing technology

Furthermore, there is a need to develop technologies to use these ink materials to form fine patterns in a large scale. First, patterns are formed on silicon wafer and glass surfaces using electron beam lithography. These master patterns are copied on silicone resin. Using this soft silicone rubber as a stamper, the patterns are printed in the various types of above-mentioned ink. This technology was made public as soft lithography or micro-contact printing by Whitesides *et al.* of Harvard University in 1991, and drew world-wide attention. However, although it made formation of fine patterns of several tens nm possible, it was not practical as the printable surface area was less than 1 inch square. We, at AIST, in collaboration with private companies, have improved this technology under the “Technological Development of Superflexible Display Components Project (2006-2009)” of New Energy and Industrial Technology

Development Organization (NEDO). We were successful in printing thin lines (L/S: 2 μm) and words (AIST line width: 1 μm) all over a 6 inch square surface (Fig. 2).

With the fusion of these ink parts and nano-printing technology, there is an

expectation for an organic device that can be made by printing (Fig. 3).

Photonics Research Institute

Kiyoshi Yase, Toshihide Kamata

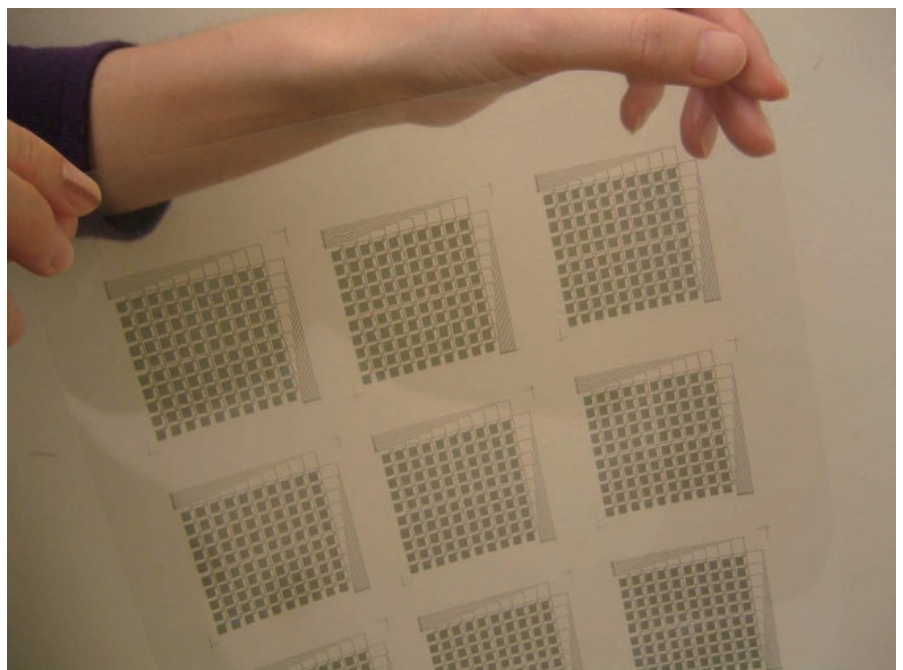

Fig. 3 Photo of organic thin film transistor (TFT) on a plastic sheet

Related articles

- [1] T. Kamata: *AIST TODAY*, 7(10), 20-21(2007) (in Japanese).
- [2] T. Kamata: *AIST TODAY*, 6(11), 36(2006) (in Japanese).
- [3] S. Uemura: *AIST TODAY*, 6(4), 26-27(2006) (in Japanese).
- [4] M. Yoshida: *AIST TODAY*, 6(1), 22-23(2006) (in Japanese).
- [5] *Kogyo zairyo*, 56(6), 18-21 (2008) (in Japanese).

Optical Information Technology

Optical Technology that Supports the Rapidly Growing Information Society

- Overview—Science & Technology, Information, Light 2
Director, Photonics Research Institute
Masanobu Watanabe
- Concept of Optical Path Network 4
Ultrafast Photonic Devices Laboratory *
Shu Namiki, Toshifumi Hasama
- Ultrafast Optical Semiconductor Switch 6
Ultrafast Photonic Devices Laboratory *
Ryoichi Akimoto
- Optical Signal Processing Technology 7
Photonics Research Institute
Hidemi Tsuchida
- Super-RENS Optical Disc 8
Center for Applied Near-Field Optics Research
Takashi Nakano
- Flexible Device 10
Photonics Research Institute
Kiyoshi Yase, Toshihide Kamata

* Present : Network Photonics Research Center

 **AIST** NATIONAL INSTITUTE OF
ADVANCED INDUSTRIAL SCIENCE AND TECHNOLOGY (AIST)

Publication Office, Public Relations Department, AIST

AIST Tsukuba Central 2, 1-1-1 Umezono, Tsukuba, Ibaraki, 305-8568, JAPAN

Tel:+81-29-862-6217 Fax:+81-29-862-6212 E-mail:prpub@m.aist.go.jp <http://www.aist.go.jp/>